

Excel 10

W7763C,D,E CHILLED CEILING CONTROLLERS LNS PLUG-INS

HONEYWELL EXCEL 5000 OPEN SYSTEM

USER GUIDE

CONTENTS

Introduction	1
Description of Devices	1
Products Covered	2
Organization of Manual	2
Applicable Literature	2
Product Names	2
Control Application	3
Control Provided	3
Setpoints	4
Bypass	5
LED/LCD	5
Energy-Saving Features	5
Occupancy Status	6
Condensation Protection	6
Operating Modes	7
Agency Listings	8
Construction	8
Controllers	8
Controller Performance Specifications	9
Configurations	10
General	10
Type of Heating and Cooling Equipment	10
Digital Input	10
Excel 10 Wall Module Options	11
Abbreviations and Definitions	12
Application Steps	13
Overview	13
Step 1. Plan The System	13
Step 2. Determine Other Bus Devices Required	13
Step 3. Lay Out Communications and Power Wiring	14
LonWorks Layout	14
Power Wiring	16
Step 4. Prepare Wiring Diagrams	17
General Considerations	17
W7763 Controller	18
LonWorks Termination Module	19
Step 5. Order Equipment	20
Step 6. Plug-Ins Configuration Screens	21
General	21
Output	22
Input	23
Equipment Control	24
Switching Levels	24
Zone Options	25
Miscellaneous	25
PID	26
Commissioning	26
ID Number	26
Step 7. Troubleshooting	27
Troubleshooting Excel 10 Chilled Ceiling Controllers and Wall Modules	27

Alarms	27
Broadcasting the Service Message	29
W7763 Controller Status LED	29
Manual Mode.....	29
Appendix A: Using A LNS tool to commission a Chilled Ceiling Controller	30
Temperature Sensor Calibration	30
Appendix B: Configuring for Master/Slave Operation	31
Output Configuration Options	31
Input Configuration Options	31
Equipment Control Options.....	31
Zone Control Options.....	31
Network Variable Binding.....	31
Appendix C: LON Interface.....	32

INTRODUCTION

Description of Devices

The W7763C, D and E Controllers are three Chilled Ceiling Controllers in the Excel 10 family product line. They cover a wide range of control applications including radiators, induction units, chilled ceiling, and chilled beam and are suitable for either wall mounting or unit mounting. Heating systems can be water or electric, and cooling systems can be chilled water supply or compressors. Extensive timing features make the W7763 especially suitable for systems using electric heat and compressors. The W7763 Controllers are capable of stand-alone operation; however, optimum

functional benefits are achieved when the network communication capabilities are used.

The zone controlled by the W7763 Controller will typically use an Excel 10 wall module with a temperature sensor for space temperature measurement, setpoint adjustment, bypass push-button, status LED, and LCD display. See page 2 for form numbers of Excel 10 wall module literature for further information.

Fig. 1 shows an overview of a typical system layout.

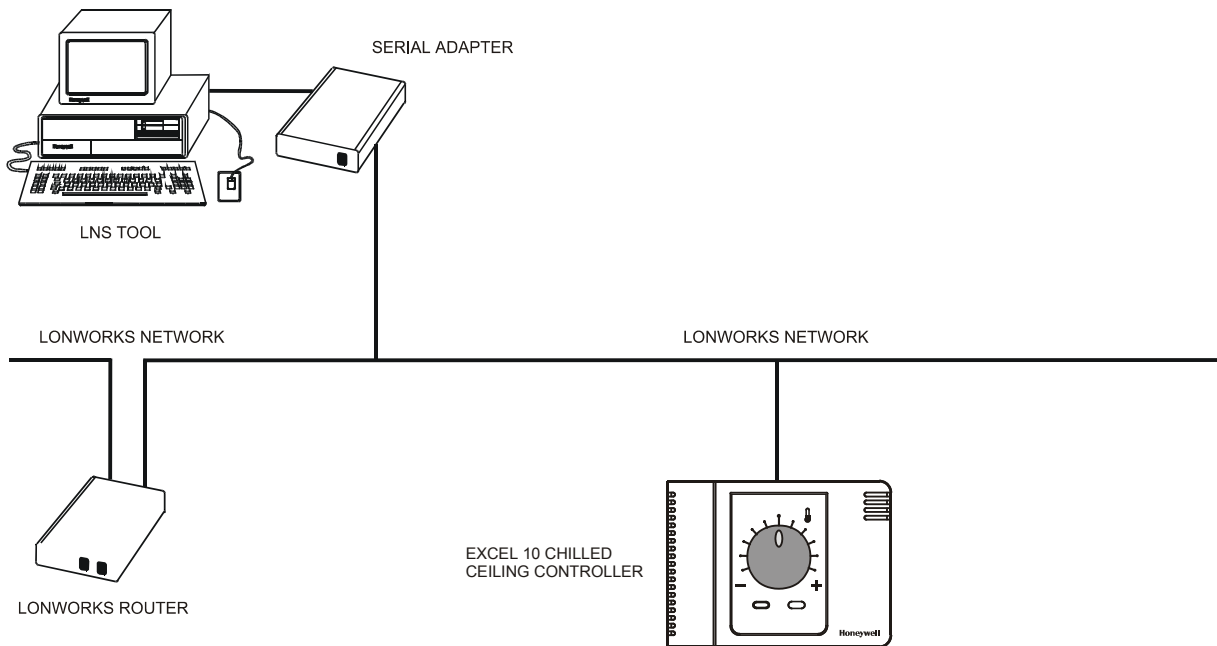

Fig. 1. Typical system overview

Products Covered

This User Guide describes how to apply the Excel 10 Chilled Ceiling Controller and the accessories to typical Chilled Ceiling applications. The specific devices covered include:

- W7763C, D and E Chilled Ceiling Controllers.
- T7460 Wall Modules.
- T7560 Wall Modules.

Organization of Manual

The Introduction and Application Steps 1 through 5 provide the information needed to make accurate ordering decisions. Application Step 6 and the Appendices include configuration engineering that can be started using a LNS tool after the devices and accessories are ordered. Application Step 7 is troubleshooting. Information provided in support of the use of third-party LonWorks communication packages to configure Chilled Ceiling Controllers is found in the Appendices.

The organization of the manual assumes a project is being engineered from start to finish. If you are adding to, or changing an existing system, the Table of Contents can guide you to the relevant information.

Applicable Literature

The following is a list of documents that contains information related to the Excel 10 Chilled Ceiling Controller and the EXCEL 5000 System in general.

prod. lit. no.	title
74-2989	Excel 10 W7763C,D,E Chilled Ceiling Controller - Specification Data
95-7485	Excel 10 W7763C,D,E Chilled Ceiling Controller - Installation Instructions
74-3083	Excel 10 T7460 Wall Modules - Specification Data
95-7610	Excel 10 T7460 Wall Modules - Installation Instructions
74-3097	Excel 10 T7560 Wall Modules - Specification Data
95-7620	Excel 10 T7560 Wall Modules - Installation Instructions
74-2697	Excel 10 T7770 Wall Modules - Specification Data
95-7538	Excel 10 T7770 Wall Modules - Installation Instructions
74-2950	Excel 10 Q7750A, Excel 10 Zone Manager - Specification Data
74-2951	Excel 10 Q7750A Excel 10 Zone Manager - Checkout and Test Manual
95-7509	Excel 10 Q7750A Zone Manager - Installation Instructions
95-7554	Excel 10 FTT/LPT 209541B Termination Module - Installation Instructions
95-7510	Excel 10 Q7751A Router - Installation Instructions
95-7511	Excel 10 Q7752A Serial Interface - Installation Instructions
74-2039	XBS User's Manual
74-5018	XBS Application Guide

Product Names

The W7763 Controller is available in three models:

- **W7763C** Chilled Ceiling Controller with integral setpoint adjustment, temperature sensor, and bypass push-button.
- **W7763D** Chilled Ceiling Controller with integral setpoint adjustment only.
- **W7763E** Chilled Ceiling Controller with no integral setpoint adjustment, sensor, or bypass push-button.

The W7763 Chilled Ceiling Controllers can use any of the following Wall Modules:

- **T7460A** with temperature sensor.
- **T7460B** with temperature sensor and setpoint adjustment.
- **T7460C** with temperature sensor, setpoint adjustment, and bypass button and LED.
- **T7770A** Wall Module with temperature sensor and optional E-Bus jack.
- **T7770B** Wall Module with temperature sensor, setpoint adjustment, and E-Bus jack.
- **T7770C** Wall Module with temperature sensor, setpoint adjustment, bypass button and LED, and E-Bus jack.
- **T7770D** Wall Module with temperature sensor, bypass button and LED, and E-Bus jack.

Other products:

- **Q7750A** Excel 10 Zone Manager.
- **Q7751A** Bus Router (US only).
- **Q7752A** Serial Adapter (US only).
- **AK3781** E-Bus (non-plenum): 22 AWG (0.325 mm²) twisted pair solid conductor, non-shielded wire (one twisted pair) (US only).
- **AK3782** E-Bus (non-plenum): 22 AWG (0.325 mm²) twisted pair solid conductor, non-shielded wire (two twisted pairs) (US only).
- **AK3791** E-Bus (plenum): 22 AWG (0.325 mm²) twisted pair solid conductor, non-shielded wire (one twisted pair) (US only).
- **AK3792** E-Bus (plenum): 22 AWG (0.325 mm²) twisted pair solid conductor, non-shielded wire (two twisted pairs) (US only).
- **C7608A** Return Air Sensor (Europe only).
- **VF20A** Strap-on Temperature Sensor (Europe only).

Control Application

Chilled Ceiling systems in commercial buildings control room temperature through the control of heat and/or cold water valves. W7763 Chilled Ceiling Controllers cover a wide range of applications including radiators, induction units, chilled ceiling and chilled beam, and fan coil units. The Chilled Ceiling controller is typically connected to an Excel 10 wall

module which incorporates a temperature sensor, setpoint and a bypass or override button. Connection of a humidity sensor and chilled water temperature sensor allow calculation of the dewpoint for condensation prevention. Fig. 2 shows a typical Chilled Ceiling control application.

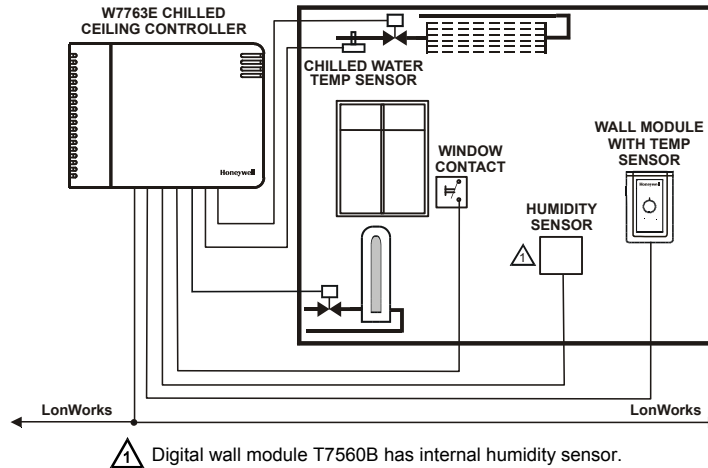

Fig. 2. Typical W7763 Chilled Ceiling control application.

Control Provided

The basic control sequence for a W7763 Chilled Ceiling Controller is shown in Fig. 3. As space temperature falls below the heating setpoint, the heating output is increased. As space temperature increases above the cooling setpoint, the cooling output is modulated to 100%. Switching levels for staged heating/cooling are configurable.

W7763 Chilled Ceiling Controllers use a PID control algorithm where each of the three parameters can be configured. There are additional configurable boost parameters (HeatBoost and CoolBoost) which specify a range outside of which the heating or cooling outputs are turned on fully for faster response (for thermal actuators this specifies the control hysteresis). The controllers are delivered with factory defaults for each of the parameters.

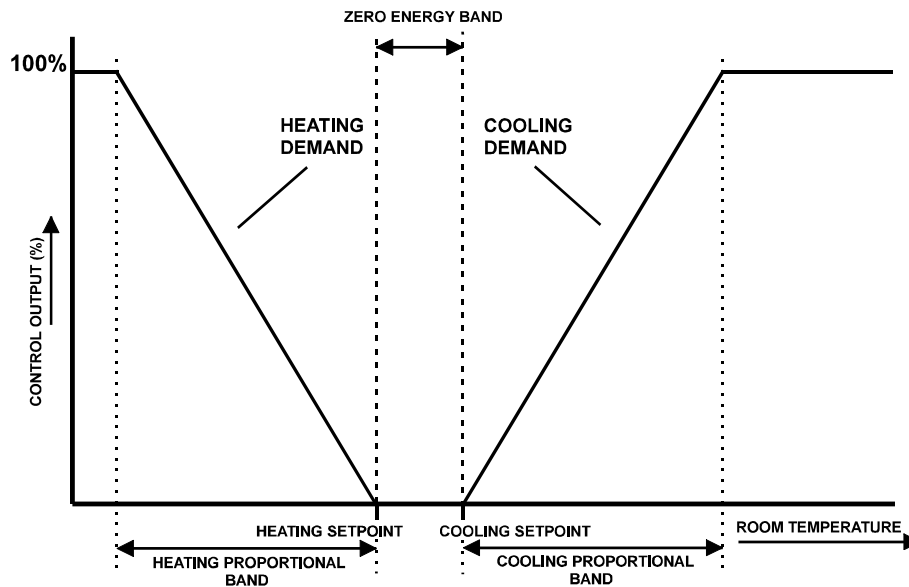

Fig. 3. Control sequence diagram.

Setpoints

Setpoint Knob

W7763C and D Chilled Ceiling Controllers have a built-in setpoint potentiometer. W7763E controllers may have an Excel 10 wall module with setpoint potentiometer connected to them. When configured **setpoint knob**, the value from the setpoint knob is used to calculate the Cooling or Heating Occupied Setpoint. There are two options that determine how the setpoint to be used by the control algorithm is calculated: Relative (or Offset) and Absolute Middle. When configured for Relative, the Wall Module setpoint knob represents a number from -5° to +5°C (-9° to +9°F) which is added to the software occupied setpoints for the heat and the cool modes (Cooling Occupied Setpoint and Heating Occupied Setpoint). When SptKnob is set to Absolute Middle, the setpoint knob becomes the center of the Zero Energy Band (ZEB) between the cooling and heating occupied setpoints. The range of the ZEB is found by taking the difference between the configured heating and cooling occupied setpoints; therefore, for Absolute Middle, the actual setpoints are found as follows:

$$\begin{aligned} \text{nvoActiveSetPt (in cooling mode)} &= \\ &\text{nvoSensor.remote_set_point+ (Cooling Occupied} \\ &\text{Setpoint - Heating Occupied Setpoint) / 2} \\ \text{nvoActiveSetPt (in heating mode)} &= \text{SrcRmTempSptHw -} \\ &\text{(Cooling Occupied Setpoint - Heating Occupied} \\ &\text{Setpoint) / 2} \end{aligned}$$

During Standby and Unoccupied modes, the remote setpoint knob is ignored, and the configured setpoints for those modes are used instead.

Setpoint Limits

Setpoint knob limits are provided by Minimum Limit Setpoint Pot and Maximum Limit Setpoint Pot. The occupied setpoints used in the control algorithms are limited by these parameters. When the setpoint knob is configured to be Absolute Middle, the lowest actual setpoint allowed is equal to Minimum Limit Setpoint Pot, and the highest actual setpoint allowed is equal to Maximum Limit Setpoint Pot. When the setpoint knob is configured to be Relative, the lowest actual setpoint allowed is equal to Heating Occupied Setpoint - Minimum Limit Setpoint Pot, and the highest allowed is equal to Cooling Occupied Setpoint + Maximum Limit Setpoint Pot.

Setpoint from Network

When not configured to use the wall module, nviSetPt must be bound to another node that provides a setpoint. When bound and a valid update is received, nviSetPt is used with the appropriate ZEB:

$$\begin{aligned} \text{ZEBoccupied} &= \text{Cooling Occupied Setpoint - Heating} \\ &\text{Occupied Setpoint} \\ \text{ZEBstandby} &= \text{Cooling Standby Setpoint- Heating Standby} \\ &\text{Setpoint} \end{aligned}$$

The Unoccupied setpoint does not depend on nviSetPt at all.

Setpoint Offset

Third party nodes may be bound to nviSetPtOffset to shift the setpoint in the range of -10 delta °C to +10 delta °C.

Table 1. Example setpoint values based upon default configuration - Absolute Middle setpoint knob (°C).

Occupancy Mode	Configured Cooling Spt.	Configured Heating Spt.	ZEB	Setpoint Knob ¹	Effective Cooling Spt. ^{2,3}	Effective Heating Spt. ^{2,4}
Occupied	23	21	2	21	22	20
Standby	25	19	6	21	24	18
Unoccupied	28	16	12	X	28	16

NOTES:

1. Sample value shown. Limited by default configuration settings to the range of 12 to 30°C.
2. Limited to the range of 10 to 35°C.
3. = Setpoint Knob + (ZEB/2)
4. = Setpoint Knob - (ZEB/2)

Table 2. Example setpoint values based upon default configuration - Relative setpoint knob (°C).

Occupancy Mode	Configured Cooling Spt.	Configured Heating Spt.	ZEB	Setpoint Knob ¹	Effective Cooling Spt. ^{2,3}	Effective Heating Spt. ^{2,4}
Occupied	23	21	2	-2	21	19
Standby	25	19	6	-2	23	17
Unoccupied	28	16	12	X	28	16

NOTES:

1. Sample value shown. Limited by default configuration settings to the range of -5 to 5°C.
2. Limited to the range of 10 to 35°C.
3. = Configured Cooling Setpoint + Setpoint Knob
4. = Configured Heating Setpoint + Setpoint Knob

Bypass

Bypass Mode

During Unoccupied periods, the bypass push-button (either on the controller itself or on the Wall Module) may be used to cause the Occupied setpoints to be used by the control algorithm. The mode may also be initiated by setting nviManOccCmd to OC_BYPASS via the network. The controller remains in Bypass mode until:

1. The bypass timer has timed out, or
2. The user again presses the Wall Module push-button to cancel Bypass mode, or
3. The occupancy schedule (nviTodEvent network input) switches the mode to Occupied.
4. The network input nviManOccCmd is set to OC_NUL.

The LED on the Wall Module indicates the current bypass mode status (see Wall Module Status LED section).

Bypass Timer

When the bypass mode has been activated, the bypass timer is set to BypTime (default of 180 minutes), at the end of which the mode reverts to the original occupancy state. See also Wall Module Bypass push-button section.

Continuous Unoccupied Mode

This mode is entered when a wall module is configured to allow it and the bypass button is pressed for four to seven seconds. This mode can also be entered via a network command (nviManOccCmd set to OC_UNOCCUPIED). The controller uses the Unoccupied setpoints. The controller remains in this mode indefinitely, or until the bypass button is pressed to exit the mode, or a network command is sent to clear the mode.

Bypass Push-Button

W7763C Chilled Ceiling Controllers have a built-in bypass push-button. W7763D and E controllers may have an Excel 10 wall module with bypass push-button connected to them. There are three ways to configure the bypass push-button (see Table 15 for further information):

NONE
 BYPASS_UNOCCUPIED
 BYPASS_ONLY

Override Priority

The Chilled Ceiling controller can be configured to arbitrate overrides coming from the bypass push-button and the network. There are two possible states which have the following meanings:

- LAST_WINS-Specifies that the last command received from either the wall module or nviManOccCmd determines the effective override state.
- NETWORK_WINS-Specifies that when nviManOccCmd is not OC_NUL, then the effective occupancy is nviManOccCmd regardless of the wall module override state.

LED/LCD

LED Override

The wall module's LED shows the override from the bypass button or from the network.

- LED on ⇒ Override Bypass
- One flash per second ⇒ Override Unoccupied
- Two flashes per second ⇒ Override Standby or Occupied
- LED off ⇒ No Override
- Four flashes per second ⇒ Controller answers network management wink command.

LED Occupancy

The wall module's LED shows the effective occupancy mode.

- LED on ⇒ Effective Occupied or Bypass
- One flash per second ⇒ Effective Standby
- LED off ⇒ Effective Unoccupied
- Four flashes per second ⇒ Controller answers network management wink command.

LCD Display

This mode is only used for T7560 Wall Modules. The occupancy mode is represented by the following symbols:

 ⇒ Effective Occupied or Bypass

 ⇒ Effective Standby

 ⇒ Effective Unoccupied

OFF ⇒ Controller is off

OFF and  ⇒ Controller is off, frost protection is enabled.

Flashing symbols represent the Override mode:

 ⇒ Override Occupied or Bypass

 ⇒ Override Standby

 ⇒ Override Unoccupied

 ⇒ Controller answers the network management wink command.

Energy-Saving Features

Standby Mode

The digital input for an occupancy sensor (usually a motion detector) provides the controller with a means to enter an energy-saving Standby mode whenever there are no people in the room. Standby mode occurs when the scheduled occupancy is Occupied and the occupancy sensor indicates no people currently in the room. If no occupancy sensor is connected directly to the controller, an occupancy sensor from another node may be bound to the network input DestOccSensor. The controller can also be put in Standby mode by setting nviManOccCmd to OC_STANDBY via the network. When in Standby mode, the W7763 uses the Standby Cooling or Heating setpoint (SptCoolStby or SptHeatStby).

Window Sensor

The digital input for a window contact provides the algorithm with a means to disable its temperature control activities if someone has opened a window or door in the room. If no window sensor is connected to the controller, the sensor from another node may be used by binding it to nviWindow. Frost protection remains active (controller enables heating circuit with room temperatures below 46°F (8°C)). Normal temperature control resumes when the window closes.

Demand Limit Control

When a high-electrical-demand signal is received from an energy management system via the LonWorks network (nviDlcShed), the controller uses Demand Limit Control Bump to shift the current setpoint (down for heating and up for cooling) by the configured value to save energy.

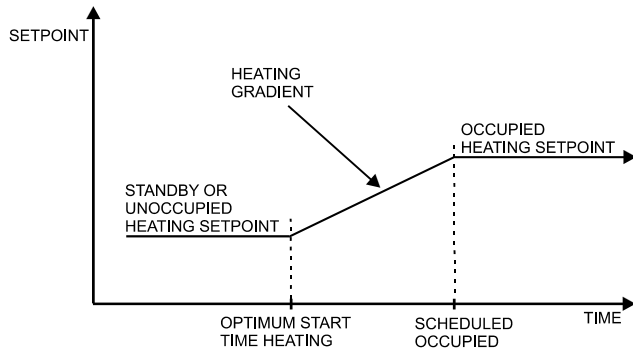

Fig. 4. Optimum start - heating.

Optimum Start Gradients

There are two parameters, Cool Rec Ramp and Heat Rec Ramp, that can be configured to cause the cooling and heating setpoints respectively to ramp up to their Occupied settings from their Unoccupied or Standby settings prior to scheduled Occupancy. The Chilled Ceiling controller uses the configured rates to determine the optimum time to start increasing the heating or cooling demand. See the following figures. The configuration parameters are in K/hour.

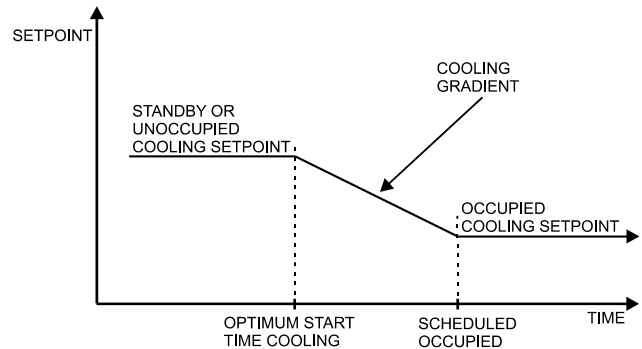

Fig. 5. Optimum start - cooling.

Occupancy Status

The occupancy status is determined based upon the following table. Manual override may come from the network input nviManOccCmd or from the bypass push-button.

Table 3. Effective Occupancy Mode Arbitration

Scheduled occupancy mode	Occupancy sensor status	Manual override status	Effective operating mode
Occupied	Occupied	Not assigned	OC_OCCUPIED
Occupied	Not occupied	Not assigned	OC_STANDBY
X	X	Occupied	OC_OCCUPIED
X	X	Unoccupied	OC_UNOCCUPIED
X	X	Standby	OC_STANDBY
Occupied	X	Bypass	OC_OCCUPIED
Standby	X	Not assigned	OC_STANDBY
Standby	X	Bypass	OC_OCCUPIED
Unoccupied	X	Not assigned	OC_UNOCCUPIED
Unoccupied	X	Bypass	OC_BYPASS

X=Don't care

Condensation Protection

W7763 Chilled Ceiling Controllers have several possibilities for protection from condensation, using a calculated or configured dewpoint and/or condensation switch.

Dewpoint Calculation

If the controller has humidity and chilled water inputs, either directly connected or from the network, it will actively calculate the dewpoint based upon room temperature and humidity. If configured to do so, the controller will close the cooling valve and issue an alarm if the chilled water temperature drops

below the dewpoint plus a configurable safety band. If no humidity input is available, the controller will use a fixed configured dewpoint.

Condensation Switch

The digital input can be configured for a condensation switch which will close the cooling valve when condensation is detected. This feature is independent of the comparison of the chilled water temperature to the dewpoint and remains active even if the dewpoint protection is disabled.

Operating Modes

The possible modes of operation are listed in Table 4.

Table 4. Modes of Operation for Excel 10 Chilled Ceiling Controller.

Mode	Description	Events Causing a Controller to Switch to This Mode
Operational Modes (NV Reference)		
START-UP AND WAIT	Control algorithms are disabled. Outputs stay in their initial positions. Physical inputs are periodically read and digital filtering of analog inputs is turned off to speed up settling time. Network input variables are received and output variables are sent periodically.	This is the first mode after an application restart.
FLOATING OUTPUTS SYNCH	The Chilled Ceiling Controller drives the floating control valves to their initial positions and then transitions to one of the control modes.	When the effective occupancy changes to unoccupied or standby, after start-up or 24 hours have elapsed since the last start-up, the Chilled Ceiling Controller transitions to this mode..
COOLING	The Excel 10 Chilled Ceiling Controller is controlling in the Cooling mode.	Network input (nviApplicMode) has a value of HVAC_COOL or HVAC_AUTO and the space temperature is above the cooling setpoint.
HEATING	The Excel 10 Chilled Ceiling Controller is controlling in the Heating mode.	Network input (nviApplicMode) has the value of HVAC_HEAT or HVAC_AUTO and the space temperature is below the heating setpoint..
MANUAL	No control algorithms are active. Physical inputs are periodically read and digital filtering of analog inputs is turned off to speed up settling time. Network input variables are received and output variables are sent periodically. Outputs may be turned on or off by settings in network input nviTest.	Network input (nviManualMode) has value of MODE_MANUAL.
FACTORY TEST	Control algorithm is disabled; special factory test program runs.	This mode is for factory testing only.
DISABLED	Control algorithms are terminated, outputs are turned off (turn-off sequences are active). Frost protection is disabled.	Network input (nviManualMode) has a value of MODE_DISABLED.

Agency Listings

Table 5 provides information on agency listings for Excel 10 Chilled Ceiling Controller products.

Table 5. Agency listings.

device	agency	comments
W7763 Chilled Ceiling Controller	CE	General Immunity per European Consortium standards EN50081-1 (CISPR 22 Class B) and EN 50082-1:1992 (based on Residential, Commercial, and Light Industrial). EN 61000-4-2 IEC 1000-4-2 (IEC 801-2) Electromagnetic Discharge. EN 50140, EN 50204 IEC 1000-4-3 (IEC 801-3) Radiated Electromagnetic Field. EN 61000-4-4 IEC 1000-4-4 (IEC 801-4) Electrical Fast Transient (Burst). Radiated Emissions and Conducted Emissions. EN 55022:1987 Class B. CISPR-22: 1985.
	FCC	Complies with requirements in FCC Part 15 rules for a Class B Computing Device.

Construction

Controllers

The Excel 10 W7763 Chilled Ceiling Controller is available in three basic models. The W7763C and D have a built-in setpoint adjustment knob, available in relative or absolute (degrees C or degrees F) scales. The W7763C also has a temperature sensor and bypass push-button and LED. The W7763E has no built-in setpoint adjustment, temperature sensor or bypass push-button, and as such requires setpoint and temperature inputs either from a direct-connected wall module or from the LonWorks network. All of the controllers are powered by 24 Vac.

All wiring connections to the controllers are made at screw terminal blocks accessible beneath a plastic safety cover. Mounting dimensions are shown in Fig. 6.



CAUTION

Turn off power prior to connecting to or removing connections from any terminals to avoid electrical shock or equipment damage.

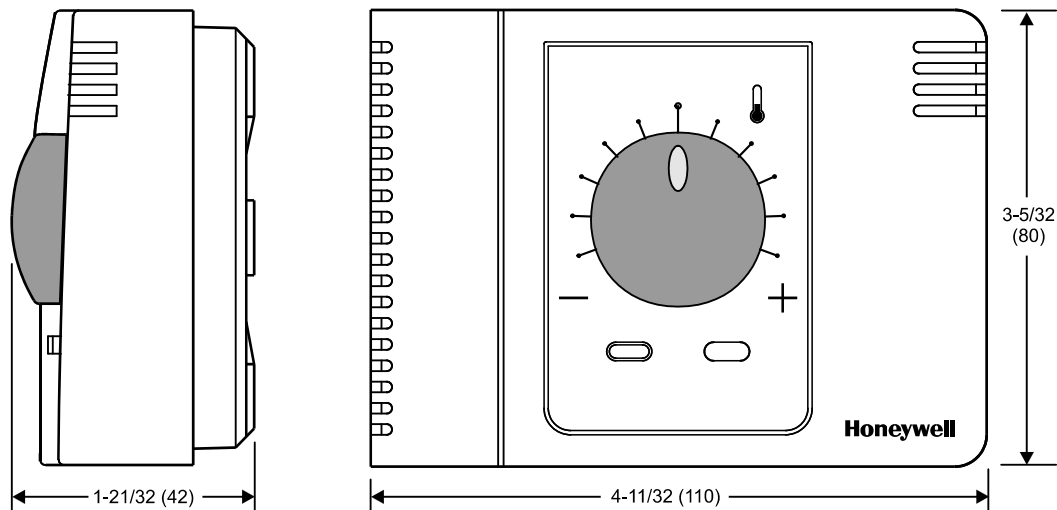

Fig. 6. W7763 construction in inches (mm).

Controller Performance Specifications

Power Supply:

24 Vac ± 20%, -15%, 50/60 Hz.

Operating Temperature:

32° to 122°F (0° to 50°C).

Shipping/Storage Temperature:

-40° to 158°F (-40° to 70°C).

Relative Humidity:

5% to 95% noncondensing

Inputs:

Temperature Sensors:
20k ohm NTC

Setpoint Potentiometer:
10k ohm

Digital Input:

Closed ≤ 400 ohms (1.5 mA)
Open ≥ 10k ohms (4.8 V)

Humidity Sensor:

0 to 10 Vdc

Outputs:

Triac voltage range:
24 Vac ± 20%.
Triac maximum current ratings:
250 mA continuous
650 mA surge for 30 sec.

IMPORTANT:

When any device is energized by a Triac, the device must be able to sink a minimum of 15 mA. If non-Honeywell motors, actuators, or transducers are to be used with Excel 10 Chilled Ceiling Controllers, compatibility must be verified.

Interoperability

The W7763 Controllers use the Echelon Bus LonTalk protocol. They support the LONMARK Functional Profile # 8020 "Fan Coil Unit Controller", version 2.0. Fig. 7 shows the implementation used.

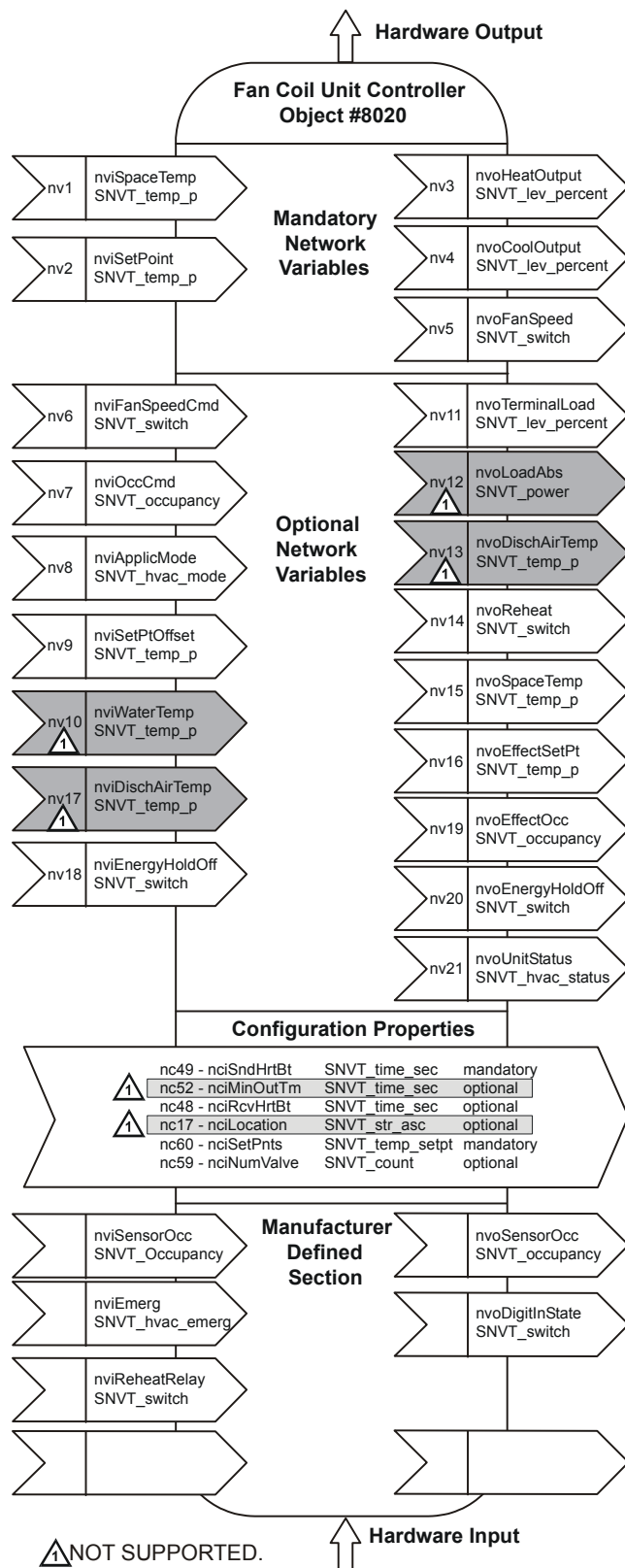

Fig. 7. LONMARK Fan Coil Unit object profile.

Configurations

General

The following sections provide an overview of the Excel 10 Chilled Ceiling Controller options related to inputs and outputs. See Application Step 6. Plug-Ins Configuration Screens for a complete list of configuration options and defaults.

Table 6. Hardware options summary.

option	possible configurations
Chilled Ceiling system type	two-pipe four-pipe
Heating actuator type	floating floating-mid (one for heat/cool) ¹ one-stage two-stage three-stage PWM thermal
Cooling actuator type	floating floating-mid (one for heat/cool) ¹ one-stage two-stage three-stage PWM thermal
Digital input 1	not used window closed occupied sensor cool changeover movement window open unoccupied sensor heat changeover input no movement
Analog input 2	not used chilled water temperature
Analog input 3	not used humidity
Wall module option	local shared
Space temperature sensor type	none NTC non-linearized
NOTE:	¹ The floating-mid option is only for changeover applications and uses only one of the two outputs.

Type of Heating and Cooling Equipment

W7763 controllers can operate with either two-pipe or four-pipe systems. A two-pipe system requires a changeover input to the controller (hardware or network input).

W7763 controllers can operate with a variety of actuators for heating and cooling equipment. Floating actuators can be used which will require specifying the valve run time during configuration of the controller. Valve action can be configured as either direct or reverse. When in a two-pipe system with a changeover input, a floating actuator can be used which has the middle position (50%) as the zero energy position. The cool range is then 0 to 50% and the heat range 50 to 100%. The output must be configured as floating-mid.

Multi-stage systems can be controlled with up to three different stages of heating/cooling control. Switching levels are specified in % of control level (see Fig. 8) as is a hysteresis setting which applies to all switching levels. Heating and Cooling switching levels and hysteresis are specified separately. Minimum off times can be configured, and a minimum on time can also be configured.

PWM electronic valves and thermal actuators can also be connected and can be configured as either direct or reverse action. The cycle time must be specified during configuration. For PWM valves the zero and full positions must also be configured.

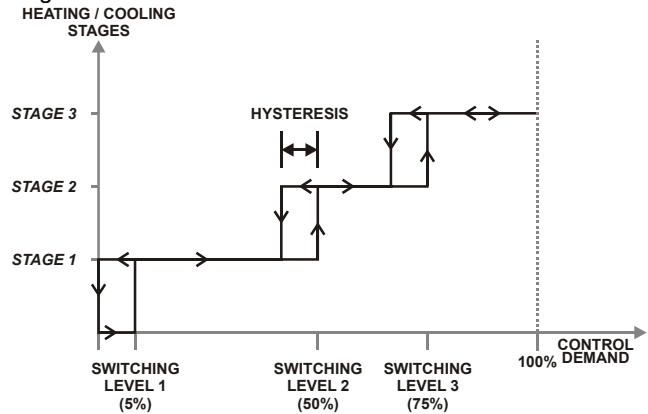

Fig. 8. Three-stage heating/cooling switching (defaults for switching levels and hysteresis shown).

Digital Input

There is a single digital input to the W7763 Controller which may be configured to accommodate an occupancy sensor, a window open/closed contact, a condensation detector, or a changeover input. It is possible to configure the input for either normally-open or normally-closed contacts for any of the switches. Choose the option which corresponds to the condition of a closed contact (input high).

The control algorithm in the Chilled Ceiling Controller uses the Occupancy Sensor, if configured, to determine the Effective Occupancy mode of operation (see Table 3). If the Time Of Day (TOD) schedule indicates an Occupied state, and the Occupancy Sensor contact is closed, the Effective Occupancy mode will be Occupied. However, if the TOD schedule indicates an Occupied state and the Occupancy Sensor contact is open, then the Effective Occupancy mode will be Standby. The flow control algorithm will then control to the Standby Cooling and Heating Setpoints.

Configuring the digital input for movement or no movement (dependent upon normally-open or normally-closed contacts) adds a delay of 15 minutes to the occupancy sensor such that the space is considered occupied until 15 minutes has elapsed since the last movement is detected.

If the digital input is configured as a window open/closed contact, heating and cooling control will be disabled while the window is detected open. Frost protection will be in effect, however, and heating control will be enabled if the temperature drops below 46°F (8°C). A set of contacts may be wired in series for multiple windows.

When configured for a condensation switch, the controller will close the cooling valve when condensation is detected.

The input may also be configured for changeover for a two-pipe system. The input can accommodate a switch that is closed for heating and open for cooling or open for heating and closed for cooling.

NOTE: The Excel 10 Chilled Ceiling Controller has limited power available (only 1.5 mA/4.8 V) for checking the digital input for contact closures. Ensure that contacts used remain within the specified resistance tolerance range (closed ≤ 400) even when aged.

Excel 10 Wall Module Options

A typical Chilled Ceiling installation requires an Excel 10 wall module containing a 20k ohm NTC room temperature sensor and additional features depending on the wall module type (see Excel 10 wall module literature for further information).

The W7763C Chilled Ceiling Controller has the following features built-in and requires no external wall module:

- setpoint adjustment
- bypass button
- status LED
- a LonWorks network access jack

The W7763D has a setpoint knob and LonWorks jack but may require a wall module for temperature sensing and bypass button/LED functions. The W7763E Controller has only the LonWorks jack and would normally require a wall module.

IMPORTANT

Wall modules with fan speed switches must not be used with W7763 Chilled Ceiling Controllers.

The Chilled Ceiling Controller can be configured to use a return air sensor rather than the sensor in the controller or wall module. Setpoint adjustments can be configured as relative or absolute, and upper and lower limits can be set. The bypass button can be configured to override the control mode to occupied for a configurable bypass time and to override the control mode indefinitely to unoccupied or it may be configured to only override to occupied. The button may also be used to cancel the override.

Common Temperature Control (Master/Slave Controllers)

When one or more Chilled Ceiling Controllers serve a common area and a single temperature sensor is to be used, a master/slave arrangement can be configured. One Excel 10 Chilled Ceiling Controller is configured for the local wall module with the desired options. The other Excel 10 Chilled Ceiling Controller(s) will be configured without wall modules and with certain network variables bound with the master controller. Refer to Appendix B of this document for more details.

IMPORTANT

The slave units must have the same HVAC equipment connected to it as the master units. The slave units will not use any internal temperature setpoints or control algorithms. The master controller determines heating/cooling output based upon setpoints and occupancy and command mode status and communicates this to the slave via the network. See Appendix B, Configuring for Master/Slave Operation, for more information,

Abbreviations and Definitions

Echelon[®] - The company that developed the LONWORKS[®] network and the Neuron[®] chips used to communicate on the LonWorks network .

EMI - Electromagnetic Interference; electrical noise that can cause problems with communications signals.

EMS - Energy Management System; refers to the controllers and algorithms responsible for calculating optimum operational parameters for maximum energy savings in the building.

EEPROM - Electrically Erasable Programmable Read Only Memory; the variable storage area for saving user Setpoint values and factory calibration information.

EPROM - Erasable Programmable Read Only Memory; the firmware that contains the control algorithms for the Excel 10 Chilled Ceiling Controller.

Firmware - Software stored in a nonvolatile memory medium such as an EPROM.

I/O - Input/Output; the physical sensors and actuators connected to a controller.

I x R - I times R or current times resistance; refers to Ohms Law: $V = I \times R$.

K - Degrees Kelvin.

LNS LON Network Service

LonWorks Segment - A LonWorks section containing no more than 60 nodes. Two segments can be joined together using a router.

NEC - National Electrical Code; the body of standards for safe field-wiring practices.

NEMA - National Electrical Manufacturers Association; the standards developed by an organization of companies for safe field wiring practices.

NV - Network Variable; an Excel 10 Controller parameter that can be viewed or modified over the LonWorks network.

OEM - Original Equipment Manufacturer; the company that builds the fan coil units.

PC - Personal Computer.

Pot - Potentiometer; a variable resistance electronic component located on Excel 10 wall modules. Used to allow user-adjusted Setpoints to be input into the Excel 10 Chilled Ceiling Controller.

TOD - Time-Of-Day; the scheduling of Occupied and Unoccupied times of operation.

VA - Volt-Amperes; a measure of electrical power output or consumption as applicable to an ac device.

Vac - Voltage alternating current; ac voltage as opposed to dc voltage.

APPLICATION STEPS

Overview

Steps one through seven, see Table 7, address considerations for engineering an Excel 10 Chilled Ceiling System. These steps are guidelines intended to aid understanding of the product I/O options, bus arrangement choices, configuration options and the Excel 10 Chilled Ceiling Controllers' role.

Table 7. Application steps.

step no.	description
1	Plan the System
2	Determine Other Bus Devices Required
3	Lay out Communication and Power Wiring
4	Prepare Wiring Diagrams
5	Order Equipment
6	Plug-Ins Configuration Screens
7	Troubleshooting

Step 1. Plan the System

Plan the use of the W7763 Controllers according to the job requirements. Determine the location, functionality and sensor or actuator usage. Verify the sales estimate of the number of W7763 Controllers and wall modules required for each model type. Also check the number and type of output actuators and other accessories required.

When planning the system layout, consider potential expansion possibilities to allow for future growth. Planning is very important to be prepared for adding HVAC systems and controllers in future projects.

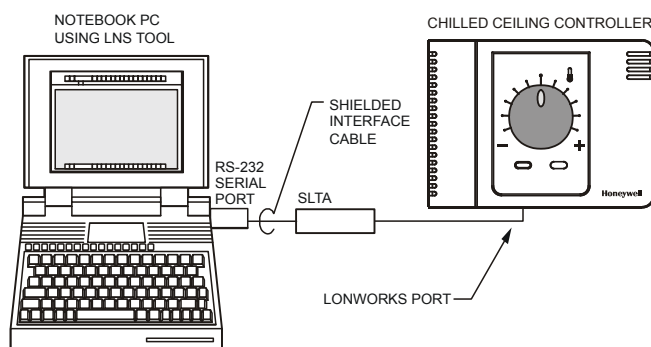

Fig. 9. Connecting the portable operator terminal to the LonWorks network.

The LonWorks communication loop between controllers must be laid out according to the guidelines applicable for that topology. Chilled Ceiling Controllers use FTT technology that allows daisy chain, star, loop or combinations of these bus configurations. See Application Step 3. Lay Out Communications and Power Wiring, for more information on bus wiring layout, and see Fig. 10, Fig. 11, and Fig. 12 in Application Step 4. Prepare Wiring Diagrams, for wiring details.

It is important to understand the interrelationships between controllers on the LonWorks network early in the job engineering process to ensure their implementation when configuring the controllers. (See Application Step 6. Plug-Ins Configuration Screens, for information on the various Excel 10 Chilled Ceiling Controller parameters and on Excel 10 Chilled Ceiling Controller point mapping).

The T7770 Wall Modules can be installed only as I/O devices, or additional wiring can be run to them for the LonWorks network. It must be determined and documented prior to installation which T7770 Wall Modules will have their LonWorks network jacks connected.

Step 2. Determine Other Bus Devices Required

A maximum of 62 nodes can communicate on a single LonWorks segment. If more nodes are required, a router is necessary. Using a router allows up to 125 nodes, divided between two LonWorks segments. The router accounts for two of these nodes (one node on each side of the router).

Table 8. LonWorks configuration rules and device node numbers.

One LonWorks Segment Example		Maximum Number of Nodes Equals 62
	Maximum number of Excel 10 Controllers	60 nodes (T7460/T7560/T7770 wall modules are not LonWorks nodes)
	Total	62 nodes
Two LonWorks Segments Example		Maximum Number of Nodes Equals 125
	Maximum number of Excel 10 Controllers in segment number one	60 nodes (T7460/T7560/T7770 wall modules are not LonWorks nodes)
	Maximum number of Excel 10 Controllers in segment number two	60 nodes (T7460/T7560/T7770 wall modules are not LonWorks nodes)
	Total	125 nodes

The maximum length of a FTT LonWorks segment is 4600 ft (1400 m) for a daisy chain configuration or 1650 ft (500 m) total wire length and (400 m) node-to-node for any other type of configuration.

NOTE: For FTT LonWorks segments the distance from each transceiver to all other transceivers and to the termination must not exceed the maximum node-to-node distance. If multiple paths exist, the longest one should be used for the calculation.

If longer runs are required, add a Router to partition the system into two segments.

In addition, all LonWorks segments require the installation of a Bus Termination Module. For a FTT LonWorks segment, one or two Termination Modules may be required depending upon the bus configuration. See Application Step 3. Lay Out Communications and Power Wiring, and the LonWorks Termination Module subsection in Application Step 4 for more details.

Step 3. Lay Out Communications and Power Wiring

LonWorks Layout

The communications bus, LonWorks, is a 78-kilobit serial link that uses transformer isolation and differential Manchester

encoding. Wire the LonWorks network using level IV 22 AWG or plenum rated level IV 22 AWG nonshielded, twisted pair, solid conductor wire as the recommended wire size (see Table 11 for part numbers). A FTT LonWorks can be wired in daisy chain, star, loop or any combination thereof as long as the maximum wire length requirements given in Step 2 are met.

NOTE: Due to the transformer isolation, the bus wiring does not have a polarity; that is, it is not important which of the two LonWorks terminals are connected to each wire of the twisted pair.

LonWorks networks can be configured in a variety of ways, but the rules listed in Table 8 always apply. Fig. 10 and Fig. 11 depict two typical daisy chain LonWorks network layouts; one as a single bus segment that has 60 nodes or less, and one showing two segments. Fig. 12 shows examples of free topology bus layouts using 2000-series devices. The bus configuration is set up using the Network Manager tool.

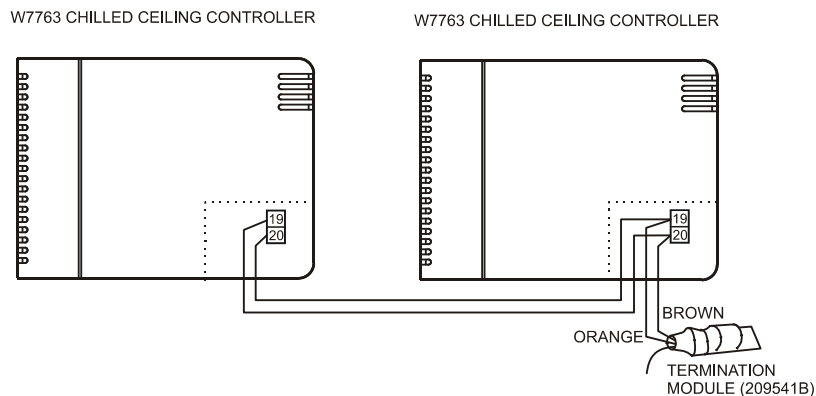

Fig. 10. LonWorks wiring layout for one daisy-chain network segment.

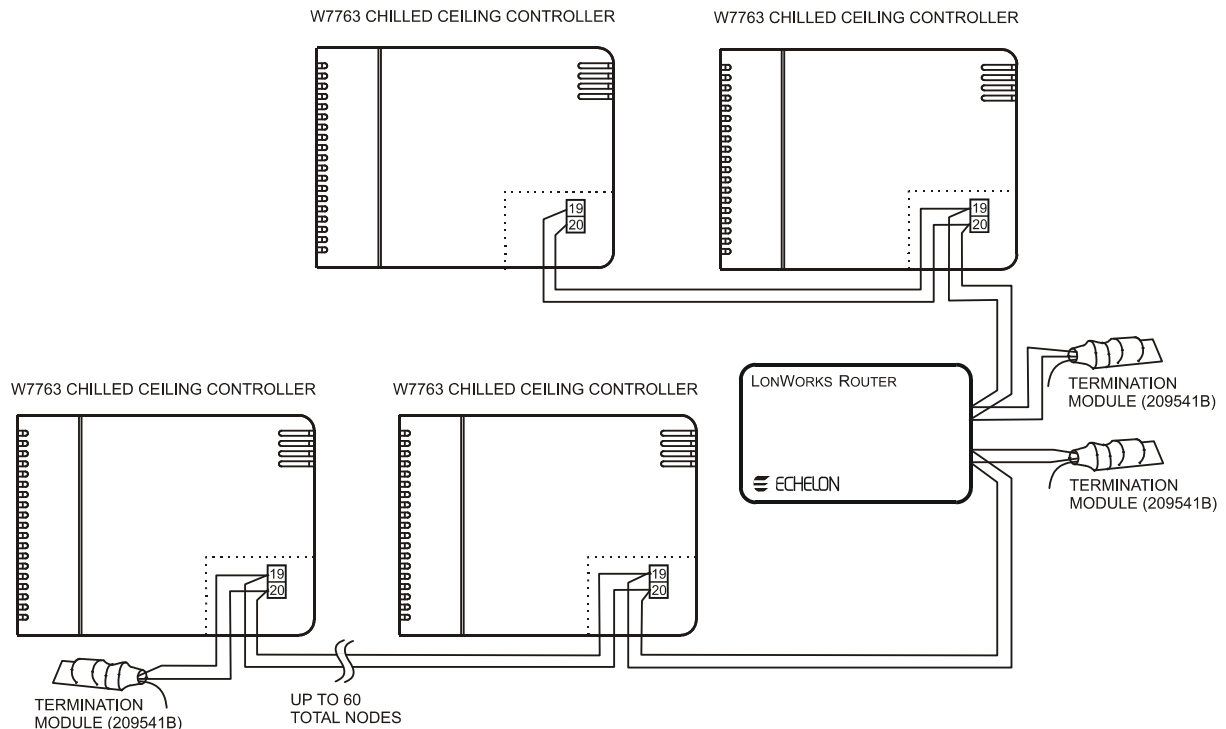

Fig. 11. LonWorks wiring layout for two daisy-chain network segments.

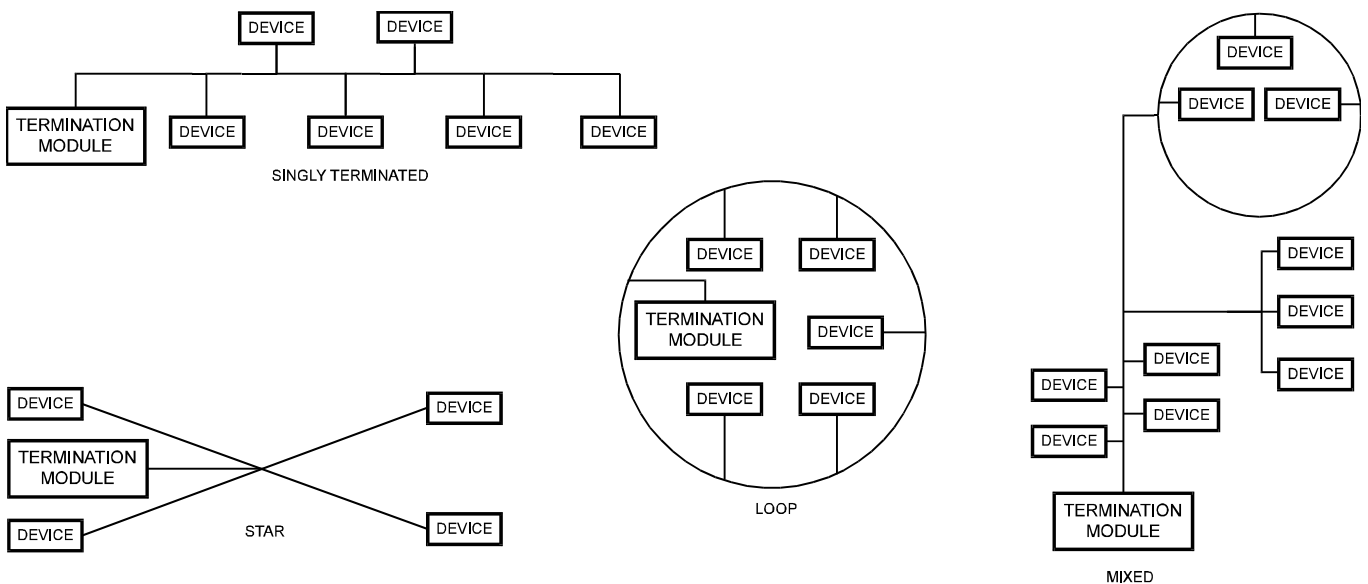

Fig. 12. Free topology LonWorks layout examples.

NOTE: See the LonWorks Termination Module section for additional details.

IMPORTANT

Notes on Communications Wiring:

- All field wiring must conform to local codes and ordinances.

- Do not use different wire types or gauges on the same LonWorks segment. The step change in line impedance characteristics would cause unpredictable reflections on the bus. When using different types is unavoidable, use a Q7751A Router at the junction.

- Do not use shielded cable for LonWorks wiring runs. The higher capacitance of the shielded cable will cause degradation of communications throughput. In noisy (high EMI) environments, avoid wire runs parallel to noisy power cables, or lines containing lighting dimmer switches, and keep at least 3 in. (76 mm) of separation between noisy lines and the LonWorks cable.
- Make sure that neither of the LonWorks wires is grounded.

200 ft (61m) run from a transformer to a W7750 CVAHU Controller drawing 37 VA using two 18 AWG (1.0 mm²) wires.

The formula is:

$$\text{Loss} = [\text{length of round-trip wire run (ft)}] \times [\text{resistance in wire (ohms per ft)}] \times [\text{current in wire (amperes)}]$$

From specification data:

18 AWG twisted pair wire has 6.38 ohms per 1000 feet.

$$\text{Loss} = [(400 \text{ ft}) \times (6.38/1000 \text{ ohms per ft})] \times [(37 \text{ VA})/(24\text{V})] = 4.0 \text{ volts}$$

This means that four volts are going to be lost between the transformer and the controller; therefore, to assure the controller receives at least 20 volts, the transformer must output more than 24 volts. Because all transformer output voltage levels depend on the size of the connected load, a larger transformer outputs a higher voltage than a smaller one for a given load. Fig. 13 shows this voltage load dependence.

In the preceding I x R loss example, even though the controller load is only 37 VA, a standard 40 VA transformer is not sufficient due to the line loss. From Fig. 13, a 40 VA transformer is just under 100 percent loaded (for the 37 VA controller) and, therefore, has a secondary voltage of 22.9 volts. (Use the lower edge of the shaded zone in Fig. 13 that represents the worst case conditions.) When the I x R loss of four volts is subtracted, only 18.9 volts reaches the controller, which is not enough voltage for proper operation.

In this situation, the engineer basically has three alternatives:

1. Use a larger transformer; for example, if an 80 VA model is used, see Fig. 13, an output of 24.4 volts minus the four volt line loss supplies 20.4 volts to the controller. Although acceptable, the four-volt line-loss in this example is higher than recommended. See the following **IMPORTANT**.
2. Use heavier gauge wire for the power run. 14 AWG (2.0 mm²) wire has a resistance of 2.57 ohms per 1000 ft which, using the preceding formula, gives a line-loss of only 1.58 volts (compared with 4.02 volts). This would allow a 40 VA transformer to be used. 14 AWG (2.0 mm²) wire is the recommended wire size for 24 Vac wiring.
3. Locate the transformer closer to the controller, thereby reducing the length of the wire run, and the line loss.

The issue of line-loss is also important in the case of the output wiring connected to the Triac digital outputs. The same formula and method are used. The rule to remember is to keep all power and output wire runs as short as practical. When necessary, use heavier gauge wire, a bigger transformer, or install the transformer closer to the controller.

IMPORTANT

No installation should be designed where the line loss is greater than two volts to allow for nominal operation if the primary voltage drops to 102 Vac (120 Vac minus 15%) or 193 Vac (230 minus 15%).

To meet the National Electrical Manufacturers Association (NEMA) standards, a transformer must stay within the NEMA limits. The chart in Fig. 13 shows the required limits at various loads.

With 100 percent load, the transformer secondary must supply between 23 and 25 volts to meet the NEMA standard.

Power Wiring

A power budget must be calculated for each Excel 10 W7763 Controller to determine the required transformer size for proper operation. A power budget is simply the summing of the maximum power draw ratings (in VA) of all the devices to be controlled by an Excel 10 W7763 Controller. This includes the controller itself, the equipment and various contactors and transducers, as appropriate, for the Excel 10 configuration.

Power Budget Calculation Example

The following is an example power budget calculation for a typical W7763 Excel 10 Chilled Ceiling Controller.

Assume a W7763 unit with a thermal actuator for cooling control and an electric actuator for heating. The power requirements are listed in Table 9.

Table 9. Power requirements

device	VA	information from
W7763C,D,E	0.5	W7763 Specification Data
Z100A Thermal actuator	12.0	Product Data
M7410A Electric Actuator	0.7	Product Data
TOTAL	13.2	

The Excel 10 System example requires 13.2 VA of peak power; therefore, a 48 VA CRT 2 (20 VA AT20A for US) Transformer is able to provide ample power for this controller and its accessories.

Table 10. VA Ratings for transformer sizing

device	description	VA
W7763C,D,E	Excel 10 Chilled Ceiling Controller	0.5
T7560A	DWM	0.2
Z100A	Thermal actuator	12.0
M7410A	Electric actuator	0.7

For contactors and similar devices, the in-rush power ratings should be used as the worst case values when performing power budget calculations. Also, the application engineer must consider the possible combinations of simultaneously energized outputs and calculate the VA ratings accordingly. The worst case, that uses the largest possible VA load, should be determined when sizing the transformer.

Line Loss

Excel 10 Controllers must receive a minimum supply voltage of 20 Vac. If long power or output wire runs are required, a voltage drop due to Ohms Law (I x R) line loss must be considered. This line loss can result in a significant increase in total power required and thereby affect transformer sizing. The following example is an I x R line-loss calculation for a

When a purchased transformer meets the NEMA standard DC20-1986, the transformer voltage-regulating ability can be considered reliable. Compliance with the NEMA standard is voluntary.

The following Honeywell transformers meet this NEMA standard:

Transformer Type	VA Rating
AT20A	20
AT40A	40
AT72D	40
AT87A	50
AK3310 Assembly	100

IMPORTANT (US ONLY)

If the W7763 Controller is used on **Heating and Cooling Equipment (UL 1995)** devices and the transformer primary power is more than 150 volts, connect the transformer secondary to earth ground, see Fig. 14.

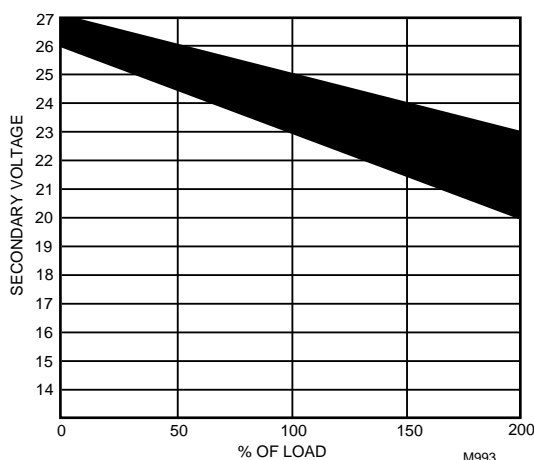

Fig. 13 NEMA class 2 transformer voltage output limits.

IMPORTANT

Notes on power wiring:

- All field wiring must conform to local codes and ordinances or as specified on installation wiring diagrams.
- To maintain NEC Class 2 and UL ratings, the installation must use transformers of 100 VA or less capacity.
- For multiple controllers operating from a single transformer, the same side of the transformer secondary must be connected to the same input terminal in each controller.
- For the W7763 Controller (which has Triac outputs), all output devices must be powered from the same transformer as the one powering the W7763 Controller.
- Use the heaviest gauge wire available, up to 14 AWG (2.0 mm²) with a minimum of 18 AWG (1.0 mm²) for all power and earth ground connections.
- To minimize EMI noise, do not run Triac and/or relay output wires in the same conduit as the input wires or the LonWorks communications wiring.
- Unswitched 24 Vac power wiring can be run in the same conduit as the LonWorks cable.

Step 4. Prepare Wiring Diagrams

General Considerations

The purpose of this step is to assist the application engineer in developing job drawings to meet job specifications. Wiring details for the W7763 Chilled Ceiling Controller are shown in Fig. 14. Table 12 gives additional details for output connections.

NOTE: For field wiring, when two or more wires are to be attached to the same connector block terminal, be sure to twist them together. Deviation from this rule can result in improper electrical contact. See Fig. 15.

Table 11 lists wiring types, sizes, and length restrictions for Excel 10 Chilled Ceiling Controller products.

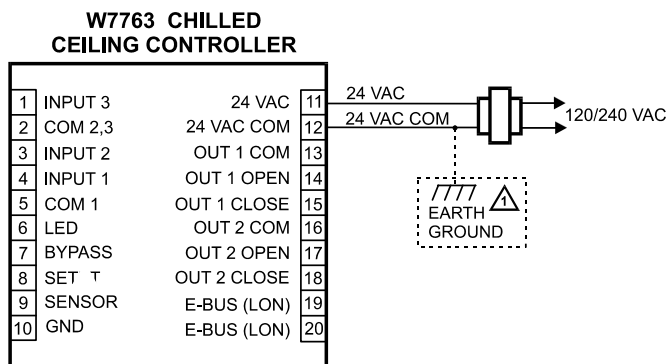

1 If the W7763 Controller is used in UL 1995 equipment and the primary power is more than 150 Vac, ground one side of the transformer.

Fig. 14 Power wiring details for one Excel 10 per transformer.

Table 11. Field wiring reference table (US part numbers shown).

Wire Function	Recommended Minimum Wire Size AWG (mm ²)	Construction	Specification or Requirement	Vendor Wire Type	Maximum Length ft (m)
LonWorks (Plenum)	22 AWG	Twisted pair solid conductor, nonshielded.	Level IV 140°F (60°C) rating	Honeywell (US) AK3791 (one twisted pair) AK3792 (two twisted pairs) (Europe: Belden 9H2201504)	See Step 2
LonWorks (Non-plenum)*	22 AWG	Twisted pair solid conductor, nonshielded.	Level IV 140°F (60°C) rating	Honeywell (US) AK3781 (one twisted pair) AK3782 (two twisted pairs) (Europe: Belden 9D220150)	See Step 2
Input Wiring Sensors Contacts	14 to 20 AWG (2.0 to 0.5 mm ²)	Multiconductor (usually five-wire cable bundle). For runs >100 ft (30 m) twisted pair or shielded cable is recommended.	140°F (60°C) rating	Standard thermostat wire	82.5 ft (25m)
Output Wiring Actuators Relays	14 AWG (2.5 mm ²) (18 AWG (1.0 mm ²) acceptable for short runs)	Any pair nonshielded (use heavier wire for longer runs).	NEC Class 2 140°F (60°C) rating	Honeywell (US) AK3702 (18 AWG) AK3712 (16 AWG) AK3754 (14 AWG) or equivalent	200 ft (60m)
Power Wiring	14 AWG (2.5 mm ²)	Any pair nonshielded (use heavier wire for longer runs).	NEC Class 2 140°F (60°C) rating	Honeywell (US) AK3754 (14 AWG) (twisted pair) AK3909 (14 AWG) single conductor or equivalent	Limited by line loss effects on power consumption. (See Line Loss subsection.)

NOTE: PVC wire must not be used where prohibited by local fire regulations.

W7763 Controller

Fig. 16 illustrates W7763 Controller terminal block assignments and wiring for a sample Chilled Ceiling installation. All connections are made at terminal blocks.

Table 12 lists wiring information for wiring all of the possible actuator types.

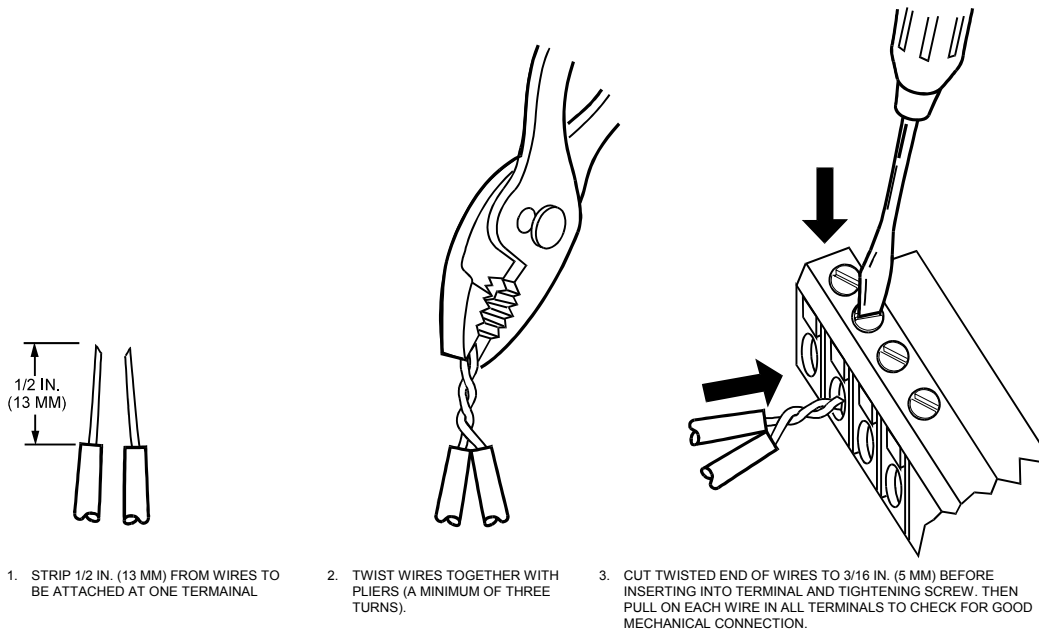

Fig. 15. Attaching two or more wires at terminal blocks.

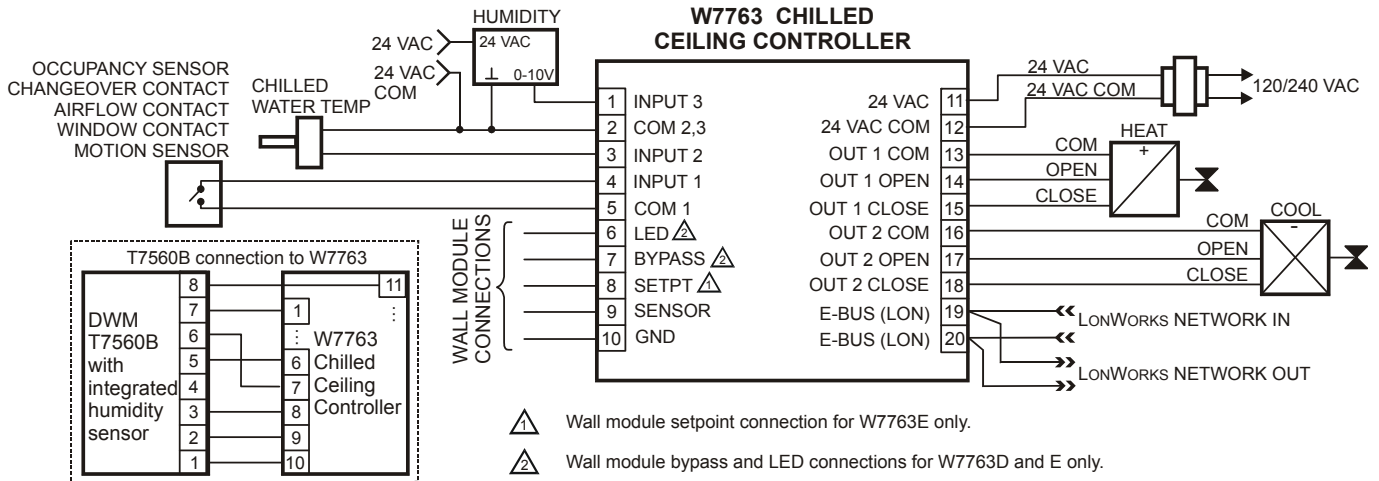

Fig. 16. W7763 Chilled Ceiling Controller wiring example.

Table 12. Output assignments for various actuator types.

Output type	Out 1 Terminal			Out 2 Terminal		
	13	14	15	16	17	18
Floating	24 Vac	open	close	24 Vac	open	close
1-stage	24 Vac	on/off	—	24 Vac	on/off	—
2-stage	24 Vac	stage 1	stage 2	24 Vac	stage 1	stage 2
3-stage	24 Vac	stage 1	stage 2	24 Vac	stage 1	stage 2
		stage 3			stage 3	
PWM	24 Vac	PWM	—	24 Vac	PWM	—
Thermal	24 Vac	on/off	—	24 Vac	on/off	—

LonWorks Termination Module

One or two LonWorks Termination Modules, part no. 209541B, are required for a LonWorks with FTT devices on it, depending upon the configuration. Double termination is only required when the network is a daisy-chain configuration and the total wire length is greater than 1640 ft (500 m). The maximum lengths described in Step 2 must be adhered to for either a daisy chain or free topology LonWorks layout. See Fig. 17 for connection details for a doubly terminated bus. See Fig. 18 for connection details for a singly terminated bus.

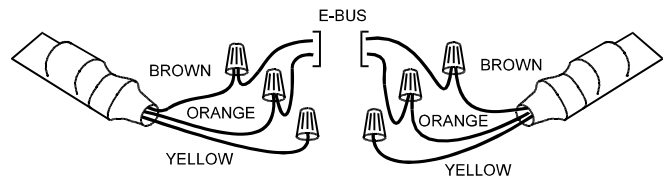

Fig. 17. Termination Module connections for a doubly-terminated FTT network.

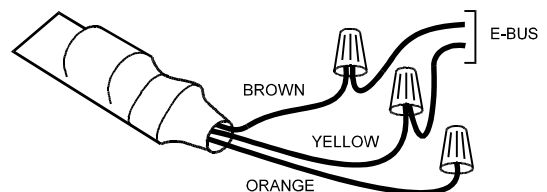

Fig. 18. Termination Module connections for a singly-terminated FTT network.

Step 5. Order Equipment

After compiling a bill of materials through completion of the previous application steps, refer to Table 13 for ordering information. Contact Honeywell for information about Controllers and Wall Modules with no logo.

Table 13. Excel 10 Chilled Ceiling Controller ordering information.

part no.	product description	comments
Excel 10 Chilled Ceiling Controllers		
W7763C1016	with setpoint knob, temp. sensor, bypass	°F absolute
W7763C1024	with setpoint knob, temp. sensor, bypass	°C absolute
W7763C1032	with setpoint knob, temp. sensor, bypass	+/- relative
W7763D1014	with setpoint knob, bypass	°F absolute
W7763D1022	with setpoint knob, bypass	°C absolute
W7763D1030	with setpoint knob, bypass	+/- relative
W7763E1003	no setpoint knob, sensor, or bypass	
Excel 10 Wall Modules		
T7460 T7560 T7770		See Excel 10 wall module literature for details.
Excel 10 Sensors		
C7068A1007 (Europe)	Air Temperature Sensor	Return air
Echelon-Based Components and Parts		
Q7751A2002 (US) (UK) (Europe)	FTT LonWorks Router	Order from local Echelon supplier (Europe)
Q7752A2001 (US) (UK) (Europe)	FTT LonWorks Serial Interface (SLTA)	Order from local Echelon supplier (Europe)
Termination Module, part no. 209541B		Two required per LonWorks segment.
205979A (US only)	SLTA Connector Cable for LonWorks	Serial interface to wall module or controller.
Cabling		
—	Serial Interface Cable, male DB-9 to female DB-9 or female DB-25.	Obtain locally from any computer hardware vendor.
Honeywell (US) AK3791 (one twisted pair) AK3792 (two twisted pairs) Belden 9H2201504 (Europe)	LonWorks (plenum): 22 AWG twisted pair solid conductor, nonshielded.	Level IV 140°F (60°C) rating
Honeywell (US) AK3781 (one twisted pair) AK3782 (two twisted pairs) Belden 9D220150 (Europe)	LonWorks (non-plenum): 22 AWG twisted pair solid conductor, nonshielded.	Level IV 140°F (60°C) rating
Honeywell (US) AK3725	Inputs: 18 AWG (1.0 mm ²) five wire cable bundle.	Standard thermostat wire
Honeywell (US) AK3752 (typical or equivalent)	Outputs/Power: 14 to 18 AWG (2.5 to 1.0 mm ²).	NEC Class 2 140°F (60°C) rating
Honeywell (US) AK3702 (typical or equivalent)	18 AWG (1.0 mm ²) twisted pair.	Non-plenum
Honeywell (US) AK3712 (typical or equivalent)	16 AWG (1.5 mm ²) twisted pair.	Non-plenum
Honeywell (US) AK3754 (typical or equivalent)	14 AWG (2.5 mm ²) two conductor.	Non-plenum

Step 6. Plug-Ins Configuration Screens

General

This section will provide details on the configuration options for W7763 Controllers. See Appendix C for reference information.

The specific parameters to be configured in each of these four categories are tabulated in the following subsections. For a complete list of all Excel 10 Chilled Ceiling Controller NV's, see Appendix C.

Using Plug-Ins

The configuration process is primarily performed in a series of screens seen as file tabs under the menu option **Application Selection** and is easily followed using the tables included in this section. There are 8 file tabs:

- Output
- Input
- Equipment Control
- Switching Levels
- Zone Options
- Miscellaneous
- PID
- Wiring (information only, no configuring).

Output

The available options for output configurations with the default values shown are listed in Table 14. See Control Provided and Configurations sections above for more information about parameters.

Table 14. Chilled Ceiling Controller output configuration options.

function	configuration options	default
Safety ¹	ceiling protection (enables dewpoint calculation and condensation protection). no ceiling protection (condensation switch input may still be used for protection)	ceiling protection
System type	two pipe (1 valve) four pipe (2 valves)	four pipe
Output1 (triac 1 and 2) control ²	not used cooling heating heat/cool changeover	heating
Output 1 (triac 1 and 2) type	floating floating-mid ³ 1-stage 2-stage 3-stage PWM thermal	floating
Output 2 (triac 3 and 4) control ²	not used cooling heating heat/cool changeover	cooling
Output 2 (triac 3 and 4) type	floating floating-mid ³ 1-stage 2-stage 3-stage PWM thermal	floating

NOTES:

1. Humidity and chilled water temperature inputs are required. If no humidity input is available, the configured dewpoint (see Zone Options) is used instead of a calculated value.
2. The output mode settings only apply to a 4-pipe system. In a 2-pipe system output1 will always operate in changeover mode.
3. The floating-mid option is only for changeover applications and uses only one of the two outputs.

The operation of the triacs based upon the output type is given in Table 12.

Input

The available options for input configurations with the default values shown are listed in Table 15. Temperature sensor settings may apply to either the built-in sensor (W7763C), remote wall module (for W7763D, E controllers), or a sensor connected directly to the controller. Override button settings may apply to either the built-in button (W7763C) or remote wall module button (for W7763D, E controllers). Setpoint knob settings may apply to the built-in setpoint knob (W7763C, D) or remote wall module (for W7763E controllers). See Control Provided and Configurations section above for more information on parameters.

Table 15. Chilled Ceiling Controller input configuration options.

function	configuration options	default
Space temperature sensor	no sensor sensor	sensor
Bypass button	none - bypass button is disabled. bypass unoccupied - bypass button overrides current mode to occupied for configurable bypass time for button press of 1.1 to 4 seconds (single press with T7560) or permanently overrides to unoccupied for button press of 4.1 to 7 seconds (more than 5 seconds with T7560). bypass - bypass button only overrides current mode to occupied and to cancel the override again.	bypass unoccupied
LED/LCD	LED override - shows override from bypass button or from network. LED occupancy - shows effective occupancy mode. LCD display - only used with T7560 Wall Modules; occupancy mode is represented by different symbols.	LED override
Setpoint knob	no knob relative absolute middle	relative
Minimum limit setpoint pot	limit for setpoint knob in either degrees F (absolute setpoint, 53.6 to 86°F) or DDF (relative setpoint, -9 to 9 DDF) (limit for setpoint knob in either degrees C (absolute setpoint, 12 to 30°C) or K (relative setpoint, -5 to 5 K))	-9 DDF (53.6°F for absolute setpoint) (-5 K (12°C for absolute setpoint))
Maximum limit setpoint pot	limit for setpoint knob in either degrees F (absolute setpoint, 53.6 to 86°F) or DDF (relative setpoint, -9 to 9 DDF) (limit for setpoint knob in either degrees C (absolute setpoint, 12 to 30°C) or K (relative setpoint, -5 to 5 K))	9 DDF (86°F for absolute setpoint) (5 K (30°C for absolute setpoint))
Digital input 1	not used window closed window open occupied sensor unoccupied sensor cool changeover heat changeover condensation no condensation movement no movement	not used
Analog input 2	cold water not used	not used
Analog input 3	humidity not used	not used

NOTES:

1. The temperature sensor option **no sensor** requires that either the Chilled Ceiling controller is configured as a slave unit receiving heating and cooling control levels from the master unit via the network, or that it is receiving temperature information over the network from another device.
2. The digital input option to be selected is the condition in which the input will be high (switch contact closed).

Equipment Control

The available options for equipment control configurations with the default values shown are listed in the following tables. See Configurations section above for more information on parameters.

Table 16. Chilled Ceiling Controller equipment control configuration options.

function	configuration options	default
Output 1 valve direction ¹	direct reverse	direct
Output 2 valve direction ¹	direct reverse	direct
Output 1 minimum stage off time	0 to 600 seconds	90 s
Output 2 minimum stage off time	0 to 600 seconds	90 s
Output 1 valve run time/PWM period/minimum stage on time	floating/floating-mid - valve run time (20 to 600 seconds) PWM - cycle time (20 to 600 seconds) 1, 2, and 3-stage - minimum on time (0 to 1200 seconds)	150 s
Output 2 valve run time/PWM period/minimum stage on time	floating/floating-mid - valve run time (20 to 600 seconds) PWM - cycle time (20 to 600 seconds) 1, 2, and 3-stage - minimum on time (0 to 1200 seconds)	150 s
PWM zero position ²	0 to 100%	0%
PWM full position ²	0 to 100%	100%

NOTES:

1. Valve action settings apply to floating, PWM, or thermal types.
2. Settings apply to both actuators if both are PWM.

Switching Levels

The available options for switching level configurations with the default values shown are listed in the following tables. See Configurations section above for more information on parameters.

Table 17. Chilled Ceiling Controller Heating/Cooling stages configuration options.

Function	Configuration options	Default
Cooling stage 1 switching level	0 to 100%	5%
Heating stage 1 switching level	0 to 100%	5%
Cooling stage 2 switching level	0 to 100%	50%
Heating stage 2 switching level	0 to 100%	50%
Cooling stage 3 switching level	0 to 100%	75%
Heating stage 3 switching level	0 to 100%	75%
Cooling hysteresis	0 to 100%,	10%
Heating hysteresis	0 to 100%	10%

Zone Options

The available options for input configurations with the default values shown are listed in the following tables. See Control Provided and Configurations sections above for more information on parameters.

Table 18. Chilled Ceiling Controller zone configuration options.

function	configuration options	default
Cooling occupied setpoint ^{1,2}	50 to 95°F (10 to 35°C)	73.4°F (23°C)
Heating occupied setpoint ^{1,2}	50 to 95°F (10 to 35°C)	69.8°F (21°C)
Cooling standby setpoint ^{1,2}	50 to 95°F (10 to 35°C)	77°F (25°C)
Heating standby setpoint ^{1,2}	50 to 95°F (10 to 35°C)	66.2°F (19°C)
Cooling unoccupied setpoint ^{1,2}	50 to 95°F (10 to 35°C)	82.4°F (28°C)
Heating unoccupied setpoint ^{1,2}	50 to 95°F (10 to 35°C)	60.8°F (16°C)
Dewpoint setpoint	50 to 95°F (10 to 35°C)	95°F (35°C)
Dewpoint safety	1.8 to 7.2 DDF (1 to 4 K)	1.8 DDF (1 K)

NOTES:

1. Default setpoints are used when there is no setpoint knob and no network setpoint input.
2. Ensure that unoccupied heating < occupied heating < occupied cooling < unoccupied cooling and standby heating < standby cooling.

Miscellaneous

The available options for the Miscellaneous tab in the Plug-Ins are listed in the following tables. See Control Provided and Configurations sections above for more information on parameters.

Table 19. Chilled Ceiling Controller miscellaneous configuration options.

function	configuration options	default
Bypass time	0 to 1080 minutes	180 minutes
Override priority	last wins - the last command from either the wall module or from the network has priority. network wins - a network command always has priority until canceled.	Last wins
Demand limit control bump	0 to 10 K	2 K
Cool rec ramp (Cooling optimum start gradient)	-20 to 0 K/hour	0
Heat rec ramp (Heating optimum start gradient)	0 to 20 K/hour	0

PID

The available options for configuring the PID parameters with the default values shown are listed in the following tables. See Control Provided section above for more information on parameters.

Table 20. Chilled Ceiling Controller PID configuration options.

function	configuration options	default
Cooling proportional gain ¹	4 to 100 K (0 = disable)	4 K
Heating proportional gain ¹	4 to 100 K (0 = disable)	4 K
Cooling reset time	10 to 3200 seconds (0 = disable)	300 s
Heating reset time	10 to 3200 seconds (0 = disable)	300 s
Cooling derivative time	1 to 3200 seconds (0 = disable)	0
Heating derivative time	1 to 3200 seconds (0 = disable)	0
Cooling boost temperature	0.5 to 10 K (0 = disable)	1 K
Heating boost temperature	0.5 to 10 K (0 = disable)	1 K

NOTES:

1. With version 1.0.2 and later firmware, it is possible to configure the proportional gain as low as 2 for PI control or 1.25 for P control.

Commissioning

Commissioning refers to the activities performed to optimize the Chilled Ceiling operation to meet the job specification requirements and overall fine-tuning of the Chilled Ceiling control. Any LNS tool can be used to perform these activities, as described in Appendix B.

Neuron[®] ID. This ID number is on a removable sticker on the side of the W7763 housing and is required for identifying the controller on the LonWorks network through the LNS tool. The ID number can either be manually entered or it can be received from the network. Pressing the bypass push-button on the wall module for a Chilled Ceiling Controller or on the controller itself causes it to broadcast a service message containing its Neuron ID number.

ID Number

Each Excel 10 Chilled Ceiling Controller is shipped with an internal Identification Number from the factory called the

Step 7. Troubleshooting

Troubleshooting Excel 10 Chilled Ceiling Controllers and Wall Modules

In addition to the following information, refer to the various Checkout and Test manuals for these products. See Applicable Literature section for form numbers.

Alarms

When an Excel 10 Chilled Ceiling Controller has an alarm condition, it reports it to the central node on the LonWorks network via the variable `nvoAlarm`. See Table 21. The information contained in `nvoAlarm` is:

- Subnet Number: The LonWorks subnet that contains the Excel 10 Chilled Ceiling Controller node that has the alarm condition.
- Node Number: The Excel 10 Chilled Ceiling Controller node that has the alarm condition.
- Alarm Type: The specific alarm being issued and return to normal. An Excel 10 Chilled Ceiling Controller can provide the alarm types listed in Table 21.

All current alarms are contained in a variable called `nvoAlarmStatus` (User Addresses `SrcAlarmStatus1`, `SrcAlarmStatus2`, and `SrcAlarmStatus3`) which is composed of three bytes (`nvoAlarmStatus.alarm_bit[n]` with $n = 0$

through 2) with a bit corresponding to each of the alarms listed in Table 21. The coding is ordered in that the least significant bit of `nvoAlarmStatus.alarm_bit[0]` corresponding to alarm type 1, the most significant bit corresponding to alarm type 8, the least significant bit of `nvoAlarmStatus.alarm_bit[1]` corresponding to alarm type 9, and so on. Even alarms that are suppressed in `nvoAlarm` (see below) are contained in `nvoAlarmStatus`.

Also, the Excel 10 Chilled Ceiling Controller variables, `nvoAlarmLog.type[n]`, where n is 0 through 4, that store the last five alarms to occur in the controller, are available.

Certain alarm conditions are suppressed conditionally as follows:

If an input network variable with failure detect is bound to the same node as `nvoAlarm`, then `nvoAlarm` and `nvoAlarmLog` do not report the related Chilled Ceiling Controller variable receive failure error, and its associated return to normal. Suppression only occurs when the `nvoAlarm` is bound to only one node using LONWORKS subnet/node addressing and only after the input variable has actually received a network variable from the node since the latest application restart (or power-up condition).

Table 21. Excel 10 Chilled Ceiling Controller alarms.

name of alarm or alarm bit	alarm type no.	meaning of alarm code or alarm bit
No Alarm/Return to Normal:		
RETURN_TO_NORMAL	128	Return to no error after being in an error condition. This code is added numerically to another alarm code to indicate that the error condition has returned to normal.
ALARM_NOTIFY_DISABLED	255	The alarm reporting has been turned off by the nviManualMode =SUPPRESS_ALARMS. No more alarms are reported until nviManualMode turns on alarm reporting or upon application restart.
NO_ALARM	0	No errors since last application restart; initial condition
Chilled Ceiling Alarms:		
ALARM_NODE_OFF	1	Control algorithm has stopped due to controller disabled, or in test mode, or other conditions
ALARM_FROST	2	The space temperature is below the frost alarm limit. The alarm condition remains until the temperature exceeds the alarm limit plus hysteresis.
ALARM_INVALID_SETPOINTS	3	One of the setpoints is not in the valid range
ALARM_TEMP_SENSOR	4	Temperature sensor failed
ALARM_SETPOINT_KNOB	5	Remote setpoint potentiometer failed
ALARM_FD_SPACE_TEMP	8	nviSpaceTemp is bound and has failed in receiving an update within its specified FAILURE_DETECT_TIME
ALARM_FD_APPL_MODE	9	nviApplicMode is bound and has failed in receiving an update within its specified FAILURE_DETECT_TIME
ALARM_FD_SETPT_OFFSET	10	nviSetPtOffset is bound and has failed in receiving an update within its specified FAILURE_DETECT_TIME
ALARM_FD_TOD_EVENT	11	nviTodEvent is bound and has failed in receiving an update within its specified FAILURE_DETECT_TIME
ALARM_FD_DLC_SHED	12	nviDlcShed is bound and has failed in receiving an update within its specified FAILURE_DETECT_TIME
ALARM_FD_HUMIDITY	13	nviSpaceRH is bound and has failed in receiving an update within its specified FAILURE_DETECT_TIME
ALARM_FD_OD_TEMP	14	nviOdTemp is bound and has failed in receiving an update within its specified FAILURE_DETECT_TIME
ALARM_FD_SENSOR_OCC	15	nviSensorOcc is bound and has failed in receiving an update within its specified FAILURE_DETECT_TIME
ALARM_FD_WINDOW	16	nviEnergyHoldOff is bound and has failed in receiving an update within its specified FAILURE_DETECT_TIME
ALARM_FD_MAN_HEAT	17	nviManHeat is bound and has failed in receiving an update within its specified FAILURE_DETECT_TIME
ALARM_FD_MAN_COOL	18	nviManCool is bound and has failed in receiving an update within its specified FAILURE_DETECT_TIME
ALARM_FD_COOL_TEMP	19	The software is not compatible with the hardware configuration specified by the hardware configuration resistor value. Compatibility is checked only once after application restart.
ALARM_H2O_TOO_COOL	20	The chilled water temperature has fallen below the dewpoint plus safety band. This causes the cooling valve to be closed.
ALARM_CONDENSATION	21	Condensation has been detected. This causes the cooling valve to be closed.

Broadcasting the Service Message

The Service Message allows a device on the LonWorks network to be positively identified. The Service Message contains the controller Neuron ID number and, therefore, can be used to confirm the physical location of a particular Excel 10 Chilled Ceiling Controller in a building.

When an *Assign Neuron ID* command is issued from the LNS tool, the node goes into the SERVICE_MESSAGE mode for one minute. In the SERVICE_MESSAGE mode, pressing the occupancy override button on the remote wall module causes the Service Message to be broadcast on the network. All other functions are normal in the SERVICE_MESSAGE mode. If an Chilled Ceiling Controller does not have a bypass button connected, press the service pin button on the controller itself, located as shown in the following figure.

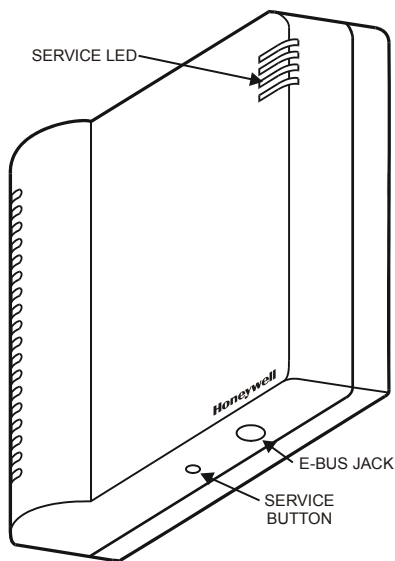

Fig. 19. Chilled Ceiling Controller LED and service button.

W7763 Controller Status LED

The LED on the upper right of the controller provides an indication of device status. The LED has the following states:

1. Off—no power to the processor.
2. Continuous on—processor is initialized state.
3. Slow blink—controlling, normal state.
4. Fast blink—controller in alarm.

Manual Mode

The Chilled Ceiling Controller can be put into a manual mode that disables the control algorithms and allows manual setting of outputs for system checkout. The variable `nviManualMode` must be set to `Mode_Manual` using the LNS tool. Inputs are read and digital filtering of analog inputs is turned off to speed up settling time. Input network variables are received, and output network variables are sent periodically. Triac outputs can be set to any combination of on/off or can be set to a test position based upon the configured valve runtime/cycle time. The override LED can be commanded on/off in this mode also.

APPENDIX A: USING A LNS TOOL TO COMMISSION A CHILLED CEILING CONTROLLER

Temperature Sensor Calibration

The temperature sensor in the Excel 10 wall modules can be calibrated to correct for sensor inaccuracies, wire resistance, etc. This allows the Excel 10 Chilled Ceiling Controller to sense the space temperature with a high degree of accuracy.

Procedure

Select the controller being worked on with the LNS tool.

From within the LNS tool, with the desired Chilled Ceiling plant loaded and the SLTA connected to the LonWorks network, perform the following procedure:

1. Select a controller symbol from a network diagram.
2. Click on **Monitor** from the **Controller** menu. Once the LNS tool logs on to the controller, the schematic for that Chilled Ceiling is displayed with point values and statuses.
3. Click on **Calibrate Point(s)...** from the **Monitor** menu. This pops up the **Temperature Calibration** dialog box.

4. The box displays the **Current Value** of the sensor and the current **Offset**; it also contains a field for entering the actual **Measured Value**. When a value is typed in and **Calibrate** is clicked, the offset value is automatically calculated, displayed, and written to the Excel 10 Chilled Ceiling Controller.

Calibrated Active Sensor	Calculated Offset	Manually Measured Value
24.73 °C	0.00 K	24.73 °C

Enter Reference Value and press Calibrate.

Calibrate Clear Close Help

Fig. 20. Calibration dialog box.

NOTE: Record the offset value to be manually restored if additional downloads are performed.

5. Click on **Close** after completing adjustments.

APPENDIX B: CONFIGURING FOR MASTER/SLAVE OPERATION

More than one W7763 Chilled Ceiling Controller may be used to control the temperature of a room. In this situation one controller must be identified as the master unit which will perform the temperature control algorithm. The other Chilled Ceiling controllers in the room are designated as slave units, and their control algorithms are disabled. The slave units receive heating, and cooling information from the master controller via network variables sent across the E-Bus. There can be a maximum of one wall module active in the room, and it must be wired directly to the master controller. If a slave controller has a wall module connected to it, the wall module will be ignored.

Configuration of the master controller is the same as for any controller operating alone in a room. Configuration of the slave controllers must follow the rules described in this section. The following sections correspond to the screens in the LNS tool used for configuring Chilled Ceiling controllers. An additional section discusses binding of network variables to support master/slave configurations.

Output Configuration Options

Slave devices must have their outputs configured identically with the master controller. The same system type and actuator types must be used. Valve run times, cycle times, and PWM zero and full position configuration options must be the same as well.

Input Configuration Options

Slave controllers may have wall modules connected to them, but they must be deactivated while the controllers are operating as slave units. They must be configured for **no temperature sensor**. The digital input may be used on the slave units for window open/closed and must be configured as such. In the case of window sensing, the window status network variable must be mapped to the master controller, as the slave controller does not execute the control algorithm.

Equipment Control Options

Valve action settings must be the same as for the master controller. Output staging hysteresis and minimum stage off times should be the same as in the master controller.

All heating and cooling stage switching levels should be identical to those of the master controller.

Zone Control Options

All zone temperature control options including PID settings and miscellaneous settings are used only by the master controller and are ignored in the slave units.

Network Variable Binding

In a master/slave configuration, the control algorithm is executed in the master controller only. Heating and cooling output as calculated by the control algorithm is then sent via the network to the slave controllers. The master controller output variables nvoHeatOutput and nvoCoolOutput must be bound using a LNS tool to the slave input variables nviManHeat and nviManCool, respectively.

For a master/slave system using heat/cool changeover, the master controller output variable nvoApplicMode must be bound to the slave controllers' input variable nviApplicMode.

The active wall module must be connected to the master controller.

APPENDIX C: LON INTERFACE

The tables are divided as follows:

Table C2—Configuration variables

Table C3—Input variables

Table C4—Output variables

Table C5—Unused variables

NOTE: Table C5 includes network variables related to reheat. The W7763 Chilled Ceiling Controller does not have outputs for direct connection of these devices, however the network inputs and outputs could be used for a master/slave configuration with a slave controller which does have such outputs (e.g., W7752D). Such a configuration is not recommended. For more information about these network variables, see form number 74-3330, W7752 Fan Coil Unit Controllers LNS Plug-Ins User Guide.

Table C2: Configuration Variables for W7763 Controllers

NvName	Field Name	Engineering Units: English (Metric) or States plus Range	Digital State or Value	Default	Comments
nciAppIVer	application_type	UBYTE, 0 to 255		0	ApplicationType identifies the current application number of the Excel 10.
nciAppIVer	version_no	UBYTE, 0 to 255		0	VersionNo identifies the version number of the Excel 10 application.
nciAppIVer	time[0]	UBYTE, 0 to 255		0	The time stamp of the last change to the Excel 10 application configuration. Time meets the ANSI C time stamp requirement specifying the number of seconds elapsed since midnight (0:00:00), January 1, 1970. It is represented in the Intel Format and is four bytes in length.
nciAppIVer	time[1]	UBYTE, 0 to 255		0	See above.
nciAppIVer	time[2]	UBYTE, 0 to 255		0	See above.
nciAppIVer	time[3]	UBYTE, 0 to 255		0	See above.
nciDeviceName	ch[0-17]	UBYTE, 0 to 255		0	nciDeviceName contains the name of each device. This is an ASCII string with a size of 18 characters. A name with all NULLs means that the device has not been configured.
nciMaxSendTime		SNVT_temp_p 0 to 6553 seconds		0s from factory	This is the configuration property used to control the maximum time that expires before the node object automatically transmits nvoStatus. This provides a heartbeat output that can be used by the destination objects to ensure that the node is still healthy. The heartbeat output may be disabled by setting nciMaxSendTime = 0.

Table C2: Configuration Variables for W7763 Controllers

NvName	Field Name	Engineering Units: English (Metric) or States plus Range	Digital State or Value	Default	Comments
nciRcvHrtBt		SNVT_time_sec 0 to 6553 seconds 0 = Disabled		0s from factory	<p>This is the configuration property used to control the maximum time that elapses after the last update to</p> <ul style="list-style-type: none"> • nviApplicMode • nviDlcShed • nviEnergyHoldOff • nviManCool • nviManHeat • nviSensorOcc • nviSetPtOffset • nviSpaceTemp • nviTodEvent <p>before these NV inputs adopt their default values. Setting nciRcvHrtBt = 0 means, that the assigned NV input does not wait for an periodic update, and that it will never revert to any default when not receiving an update. If nviSpaceTemp and nviApplicMode are not received at regular intervals that are less than the heartbeat time, the controller will assume that there is a communication failure and revert to Occupied mode.</p>
nciSndHrtBt		SNVT_time_sec 0 to 6553 seconds 0 = Disabled		0 s from factory	<p>This is the configuration property used to control the maximum time that expires before the object automatically transmits the current value of</p> <ul style="list-style-type: none"> • nvoActiveSetPt • nvoAlarm • nvoApplicMode • nvoChcStatus • nvoCoolOutput • nvoEnergyHoldOff • nvoHeatOutput • nvoSensorOcc • nvoSpaceDewPt • nvoSpaceTemp • nvoTerminalLoad • nvoUnitStatus <p>This provides a heartbeat output that can be used by the destination objects to ensure that the node is still healthy. The heartbeat output may be disabled by setting nciSndHrtBt = 0.</p>

Table C2: Configuration Variables for W7763 Controllers

NvName	Field Name	Engineering Units: English (Metric) or States plus Range	Digital State or Value	Default	Comments
nciCntrlSettings	switch_level_cool[0]	SNVT_lev_percent 0 to 100%, 0 = Disable		5%	This is the switching level to turn on stage 1 of the cooling equipment (if configured as multistage).
nciCntrlSettings	switch_level_cool[1]	SNVT_lev_percent 0 to 100%, 0 = Disable		50%	This is the switching level to turn on stage 2 of the cooling equipment (if configured as multistage).
nciCntrlSettings	switch_level_cool[2]	SNVT_lev_percent 0 to 100%, 0 = Disable		75%	This is the switching level to turn on stage 2 of the cooling equipment (if configured as multistage).
nciCntrlSettings	switch_level_heat[0]	SNVT_lev_percent 0 to 100%, 0 = Disable		5%	This is the switching level to turn on stage 1 of the heating equipment (if configured as multistage).
nciCntrlSettings	switch_level_heat[1]	SNVT_lev_percent 0 to 100%, 0 = Disable		50%	This is the switching level to turn on stage 2 of the heating equipment (if configured as multistage).
nciCntrlSettings	switch_level_heat[2]	SNVT_lev_percent 0 to 100%, 0 = Disable		75%	This is the switching level to turn on stage 3 of the heating equipment (if configured as multistage).
nciCntrlSettings	staging_hysteresis[0]	SNVT_lev_percent 0 to 100%		10%	This value only applies to cool outputs configured as multistage outputs and specifies the hysteresis between switching the cool stages ON and OFF.
nciCntrlSettings	staging_hysteresis[1]	SNVT_lev_percent 0 to 100%		10%	This value only applies to heat outputs configured as multistage outputs and specifies the hysteresis between switching the heat stages ON and OFF.
nciEnergyManag	si_dlc_setpt_bump	SNVT_temp_p 0 to 10 K		2 K	This is used to shift the temperature setpoint during demand limit control load shedding. When nviDlcShed is different from zero, the current occupancy setpoint will be decreased by this value for heating and increased for cooling.
nciEnergyManag	si_optstart_grad[0]	SNVT_temp_p -20 to 0 K/hr		0 K/hr	This is the cooling gradient used by the optimum start function to calculate the optimum time for starting to decrease the effective setpoint smoothly from the unoccupied or standby cooling setpoint to the occupied cooling setpoint.

Table C2: Configuration Variables for W7763 Controllers

NvName	Field Name	Engineering Units: English (Metric) or States plus Range	Digital State or Value	Default	Comments
nciEnergyManag	si_optstart_grad[1]	SNVT_temp_p 0 to 20 K/hr		0 K/hr	This is the heating gradient used to determine the optimum time to start increasing the current effective setpoint smoothly to the occupied setpoint at the beginning of scheduled occupancy.
nciChcConfig	room_temp_sensor	BYTE NO_TEMP_SENSOR NTC_NON_LINEARIZED	0 2	NTC_NON_LINEARIZED	This specifies whether a direct wired room temperature sensor is connected to the node or room temperature value from the network is used.
nciChcConfig	DI1_config	BYTE DI_WINDOW_CLOSED DI_OCCUPIED_SENSOR DI_AIR_FLOW DI_CHANGEOVER_COOL DI_WINDOW_OPEN DI_UNOCCUPIED_SENS DI_CHANGEOVER_HEAT DI_CONDENSATION DI_NO_CONDENSATION DI_MOVEMENT DI_NO_MOVEMENT DI_NOT_USED	0 1 2 3 4 5 7 8 9 10 11 255	DI_NOT_USED	This variable specifies the digital input function and type of switch. The option to be selected is the one which is the condition for a closed switch contact (e.g., normally-closed window switch contact = DI_WINDOW_CLOSED, normally-open window switch contact = DI_WINDOW_OPEN). NOTE: The digital input cannot be configured for an airflow detector with the LNS tool. DI_MOVEMENT and DI_NO_MOVEMENT are supported starting with CHC2 version 1.0.2. These configuration settings cause the controller to retain the occupied state for 15 minutes after the last movement is detected.
nciChcConfig	AI2_config	BYTE AI2_COLD_WATER AI2_NOT_USED	0 255	AI2_NOT_USED	When configured to AI2_COLD_WATER, a sensor is used to limit the chilled water temperature. If the chilled water exceeds the dewpoint limit (excluding safety band) for more than 5 minutes, the cooling valve will be closed and the alarm ALARM_H2O_TOO_COLD will be issued. Heat outputs operate normally. If the chilled water temperature is provided from the network (nviCoolTemp), it has priority over a locally wired sensor.
nciChcConfig	AI3_config	BYTE AI3_HUMIDITY AI3_NOT_USED	0 255	AI3_NOT_USED	When configured to AI3_HUMIDITY an analog humidity sensor is supported which is used to calculate the dewpoint. If the humidity level is provided from the network (nviSpaceRH), it has priority over a locally wired sensor.

Table C2: Configuration Variables for W7763 Controllers

NvName	Field Name	Engineering Units: English (Metric) or States plus Range	Digital State or Value	Default	Comments
nciChcConfig	DewpointSetPt	SNVT_temp_p 10 to 35°C		35°C	This defines the chilled ceiling water temperature setpoint to avoid condensation in applications without a humidity sensor or if the humidity sensor fails. If a humidity sensor is available (locally or via nviSpaceRH), this variable will be ignored.
nciChcConfig	DewpointSafety	SNVT_temp_p 1 to 4 K		1 K	This is the dewpoint safety band for limiting the cold ceiling inlet temperature to above the dew point to prevent condensation.
nciChcConfig	chilled_ceiling	Bit NO YES	0 1	YES	This configuration variable enables dewpoint protection. If the chilled water temperature falls below the dewpoint (either calculated from humidity and room temperature or from nciChcConfig.DewpointSetPt) plus the safety band (nciChcConfig.DewpointSafety), the cooling valve is closed. If not configured for dewpoint protection, the condensation switch (either direct wired or via nviCondensation) will still close the cooling valve if condensation is detected..
nciChcConfig	output_mode[0]	BYTE OUTP_COOLING OUTP_HEATING OUTP_CHANGEOVER OUTP_NOT_USED	0 1 2 255	OUTP_HEATING	This specifies the operating mode of the output 1.
nciChcConfig	output_mode[1]	BYTE OUTP_COOLING OUTP_HEATING OUTP_CHANGEOVER OUTP_NOT_USED	0 1 2 255	OUTP_COOLING	This specifies the operating mode of the output 2. This setting is ignored for nciNumValve = TWO_PIPE.

Table C2: Configuration Variables for W7763 Controllers

NvName	Field Name	Engineering Units: English (Metric) or States plus Range	Digital State or Value	Default	Comments
nciChcConfig	output_type[0]	BYTE FLOATING ONE_STAGE TWO_STAGE THREE_STAGE PWM THERMAL FLOATING_MID	0 1 2 3 4 5 6	FLOATING	This specifies the output type to drive the connected actuator for the output 1: FLOATING/FLOATING_MID - This setting considers valve_reverse[] and cycle_time[]. Synchronization is performed at every restart and at least once per day. ONE_STAGE - Triac 2 is not used. TWO_STAGE/THREE_STAGE - Triac 1 and 2 used (triac 1 and 2 both on for stage 3). When configured as multistage, cycle_time and min_stage_off_time are considered. PWM/THERMAL - Triac 2 is not used. Triac 1 operates as a pulse-width modulated output, and the cycle time must be specified in cycle_time[]. For PWM outputs, PwmZeroPosn and PwmFullPosn must also be specified.
nciChcConfig	output_type[1]	BYTE FLOATING ONE_STAGE TWO_STAGE THREE_STAGE PWM THERMAL FLOATING_MID	0 1 2 3 4 5 6	FLOATING	This specifies the output type to drive the connected actuator for the output 2 (see above).
nciChcConfig	valve_reverse_0	Bit DIRECT REVERSE	0 1	DIRECT	This setting applies to outputs only that have been configured as FLOATING, PWM, or THERMAL and specifies the direct/reverse operation of output 1.
nciChcConfig	valve_reverse_1	Bit DIRECT REVERSE	0 1	DIRECT	This setting applies to outputs only that have been configured as FLOATING, PWM, or THERMAL and specifies the direct/reverse operation of output 2.
nciChcConfig	cycle_time[0]	SNVT_time_sec 0 to 1200 s for stage output 0 to 600 s for floating output 20 to 600 s for PWM output		150 s for floating	This specifies for the output 1 configured as <ul style="list-style-type: none"> • FLOATING: the runtime of the valve (time to run from fully closed to fully open) • PWM: the cycle time • ONE_STAGE, TWO_STAGE, and THREE_STAGE: minimum ON time before switching to the next stage.

Table C2: Configuration Variables for W7763 Controllers

NvName	Field Name	Engineering Units: English (Metric) or States plus Range	Digital State or Value	Default	Comments
nciChcConfig	cycle_time[1]	SNVT_time_sec 0 to 1200 s for stage output 0 to 600 s for floating output 20 to 600 s for PWM output		150 s for floating	This specifies for the output 2 configured as <ul style="list-style-type: none"> • FLOATING: the runtime of the valve (time to run from fully closed to fully open) • PWM: the cycle time • ONE_STAGE, TWO_STAGE, and THREE_STAGE: minimum ON time before switching to the next stage.
nciChcConfig	min_stage_off_time[0]	SNVT_time_sec 0 to 600 seconds		90 s	This is only used for ONE_STAGE, TWO_STAGE, and THREE_STAGE output 1 and specifies the minimum OFF time before switching to the next stage.
nciChcConfig	min_stage_off_time[1]	SNVT_time_sec 0 to 600 seconds		90 s	This is only used for ONE_STAGE, TWO_STAGE, and THREE_STAGE output 2 and specifies the minimum OFF time before switching to the next stage.
nciChcConfig	PwmZeroPosn	SNVT_lev_percent 0 to 100%		0%	This specifies the zero position for PWM actuators. This setting applies to PWM actuators only and is used for both actuators if both are configured as PWM actuators.
nciChcConfig	PwmFullPosn	SNVT_lev_percent 0 to 100%		100%	This specifies the fully open position for PWM actuators. This setting applies to PWM actuators only and is used for both actuators if both are configured as PWM actuators.
nciChcGains	si_pid_Xp[0]	SNVT_temp_p 1.25 to 100 K, 0 = Disable		4 K	This is the throttling range for use in the proportional portion of the PID loop gain for the cooling mode. Since CHC2 version 1.0.2, the range of configurable values is 2 to 100 K for PI or 1.25 for P control. For older versions, the valid range is 4 to 100 K.
nciChcGains	si_pid_Xp[1]	SNVT_temp_p 1.25 to 100 K, 0 = Disable		4 K	This is the throttling range for use in the proportional portion of the PID loop gain for the heating mode. Since CHC2 version 1.0.2, the range of configurable values is 2 to 100 K for PI or 1.25 for P control. For older versions, the valid range is 4 to 100 K.
nciChcGains	si_pid_Tn[0]	SNVT_time_sec 10 to 3200 seconds 0 = Disable		300 s	This is the integral time for use in the integral portion of the PID loop gain for the cooling mode.
nciChcGains	si_pid_Tn[1]	SNVT_time_sec 10 to 3200 seconds 0 = Disable		300 s	This is the integral time for use in the integral portion of the PID loop gain for the heating mode.

Table C2: Configuration Variables for W7763 Controllers

NvName	Field Name	Engineering Units: English (Metric) or States plus Range	Digital State or Value	Default	Comments
nciChcGains	si_pid_Tv[0]	SNVT_time_sec 10 to 3200 seconds 0 = Disable		0 s	This is the derivative time for use in the derivative portion of the PID loop gain for the cooling mode.
nciChcGains	si_pid_Tv[1]	SNVT_time_sec 10 to 3200 seconds 0 = Disable		0 s	This is the derivative time for use in the derivative portion of the PID loop gain for the heating mode.
nciChcGains	si_boost[0]	SNVT_temp_p 0.5 to 10 K 0 = Disable		1 K	This is the temperature range to be added to the cooling setpoint, above which the cooling output is fully open to allow a faster response. For thermal actuators it is the hysteresis for thermal control algorithm.
nciChcGains	si_boost[1]	SNVT_temp_p 0.5 to 10 K 0 = Disable		1 K	This is the temperature range to be subtracted from the heating setpoint, below which the heating output is fully open to allow a faster response. For thermal actuators it is the hysteresis for thermal control algorithm.
nciNumValve		SNVT_count TWO_PIPE FOUR_PIPE	1 2	FOUR_PIPE	This is the configuration property used to specify a two-pipe system (one valve) or a four-pipe system (two valves). If set to TWO_PIPE, only the output terminals for output1 are used. If set to FOUR_PIPE, output1 and output2 are defined by nciChcConfig.output_mode[].
nciSetPnts	occupied_cool	SNVT_temp_p 10 to 35°C		23°C	This is the default setpoint for the occupied cooling setpoint that is used in case there is no locally wired setpoint knob or nviSetpoint has not been bound. Where the ZEB for occupied is used, this derives from the difference of occupied_cool and occupied_heat.
nciSetPnts	standby_cool	SNVT_temp_p 10 to 35°C		25°C	This is the configured setpoint that applies to the standby cooling mode. Where the ZEB for standby is used, it derives from the difference of standby_cool and standby_heat.
nciSetPnts	unoccupied_cool	SNVT_temp_p 10 to 35°C		28°C	This is the configured setpoint that applies to the unoccupied cooling mode.
nciSetPnts	occupied_heat	SNVT_temp_p 10 to 35°C		21°C	This is the default setpoint for the occupied heating setpoint that is used in case there is no locally wired setpoint knob or nviSetpoint has not been bound. Where the ZEB for occupied is used, this derives from the difference of occupied_cool and occupied_heat.

Table C2: Configuration Variables for W7763 Controllers

NvName	Field Name	Engineering Units: English (Metric) or States plus Range	Digital State or Value	Default	Comments
nciSetPnts	standby_heat	SNVT_temp_p 10 to 35°C		19°C	This is the configured setpoint that applies to the standby heating mode. Where the ZEB for standby is used, it derives from the difference of standby_cool and standby_heat.
nciSetPnts	unoccupied_heat	SNVT_temp_p 10 to 35°C		16°C	This is the configured setpoint that applies to the unoccupied heating mode.
nciWallMod	ui_bypass_time	UWORD 0 to 1080 minutes		180 min	This is the parameter that determines the time the controller remains in OCCUPIED mode before reverting to the original occupancy mode after pressing the override button at the wall module or initiating BYPASS via the network. When the bypass mode has been activated, the bypass timer is set to ui_bypass_time. When the timer expires, nvoChcStatus.occ_status.hw_override reverts from OC_BYPASS to OC_NUL to quit the bypass override function.
nciWallMod	si_low_setpt	SNVT_temp_p -5 to 5 K for relative 12 to 30°C for absolute		-5 K (relative)	This is the low limit for the setpoint knob. It can be relative or absolute depending on the configuration in nciWallMod.set_pnt_knob.
nciWallMod	si_high_setpt	SNVT_temp_p -5 to 5 K for relative 12 to 30°C for absolute		5 K (relative)	This is the high limit for the setpoint knob. It can be relative or absolute depending on the configuration in nciWallMod.set_pnt_knob.
nciWallMod	si_space_temp_zero_cal	SNVT_temp_p -5 to 5 K		0 K	The space temperature sensor is corrected by adding this calibration setting (an offset value) to the sensed value.
nciWallMod	use_wall_mod_st_pt	Bit NO YES	0 1	YES	This specifies whether the setpoint used is from the knob on the wall module connected to the controller or if from the network via nciTempSetPts. If set to NO, all setpoints to be used come from the network via nciTempSetPts. If set to YES, an additional option set_pnt_knob must be set to specify type of setpoint adjustment (see below).

Table C2: Configuration Variables for W7763 Controllers

NvName	Field Name	Engineering Units: English (Metric) or States plus Range	Digital State or Value	Default	Comments
nciWallMod	set_pnt_knob	2 Bits OFFSET ABSOLUTE_MIDDLE	0 2	OFFSET	This setting specifies the usage of the setpoint knob on the wall module for the occupied setpoint. OFFSET specifies a relative scale on the wall module where the setpoint is calculated by adding the setpoint potentiometer value (± 5 K) to the appropriate value of nciTempSetPts. ABSOLUTE_MIDDLE specifies an absolute scale on the wall module. The setpoint knob directly determines the center point of occupied cooling and heating setpoints. The respective cooling and heating setpoint is determined by the setpoint knob position adding or subtracting half of the user selectable ZEB defined in nciSetPnts.<occ_mode>_cool or nciSetPnts.<occ_mode>_heat . This applies to <occ_mode> OCCUPIED and STANDBY.
nciWallMod	override_type	2 Bits NO_BUTTON BYPASS_UNOCCUPIED BYPASS	0 1 2	BYPASS_UNOCCUPIED	This setting determines the behavior of the override button. BYPASS_UNOCCUPIED allows overriding the current occupancy mode to OCCUPIED for a configurable bypass time, or causing a permanent override to UNOCCUPIED. BYPASS allows only the temporary override to OCCUPIED and canceling it.
nciWallMod	override_priority	Bit LAST_WINS NETWORK_WINS	0 1	LAST_WINS	This setting configures the priority of the local (wall module) or central (network interface) override concerning override button. If NETWORK_WINS is set and the network sends value NUL, then the override button is active.
nciWallMod	display_type	Bit LED_OVERRIDE LED_OCCUPANCY LCD_DISPLAY	0 1 2	LED_OVERRIDE	This setting configures the display of occupancy and/or override. LED_OVERRIDE shows the override from the bypass button or from the network. LED_OCCUPANCY shows the effective occupancy mode. LCD_DISPLAY is only used for T7560 Wall Modules. The display shows the occupancy mode with different symbols, and the override mode with flashing symbols.

Table C3: Input Variables for W7763 Controllers

NvName	Field Name	Engineering Units: English (Metric) or States plus Range	Digital State or Value	Default	Comments
nviApplicMode		SNVT_hvac_mode HVAC_AUTO HVAC_HEAT HVAC_COOL HVAC_OFF HVAC_NUL	0 1 3 6 255	HVAC_AUTO (if bound but fails to be received or at application restart)	This is an input that coordinates the controller operation with the main equipment controller. Dependent on the supply energy available, the main equipment controller commands the Chilled Ceiling controller to operate in heat mode only, cool mode only or heat and cool mode if appropriate to the configuration. HVAC_AUTO means that both heating and cooling equipment are available, and the current mode is determined by the control algorithm depending upon the room temperature and effective setpoint. HVAC_AUTO is invalid for changeover applications. When the Digital input is configured as Heat/Cool changeover input, this input will always have priority over the network nviApplicMode's HVAC_HEAT or HVAC_COOL.
nviCondensation	value	SNVT_switch 0 to 100%		0 (at application restart)	This input allows use of a condensation switch from another node on the network. The network input has priority over a sensor connected directly to the controller.
nviCondensation	state	SNVT_switch OFF ON NUL	0 1 255	NUL (at application restart)	See above.
nviCoolTemp		SNVT_temp_p 0 to 70°C 327.67°C = INVALID		INVALID (at application restart)	This is the input for the chilled water temperature coming from another node on the network to be used for dewpoint protection. It is compared to either the calculated dewpoint or configured dewpoint (if no humidity sensor is available) plus the safety band and causes the controller to shut down the cooling valve if it is below the limit. The network input has priority over a sensor connected directly to the controller.
nviDlcShed		BYTE NORMAL SETPOINT_SHIFT	0 1	0 (if bound but fails to be received or at application restart)	This is an input from an energy management system. When it is 0, the temperature control algorithm operates in a normal mode. When it is 1, the effective setpoint will be shifted by the amount defined in nciEmergyManag.si_dlc_setpt_bump. For cooling the effective setpoint will be increased, for heating the effective setpoint will be decreased always regarding the frost limits.

Table C3: Input Variables for W7763 Controllers

NvName	Field Name	Engineering Units: English (Metric) or States plus Range	Digital State or Value	Default	Comments
nviEmerg		SNVT_hvac_emerg EMERG_NORMAL EMERG_PRESSURIZE EMERG_DEPRESSURIZE	0 1 2	EMERG_NORMAL (at application restart)	It is an emergency input from a device that determines the correct action during a given emergency (such as a fire). <ul style="list-style-type: none"> EMERG_NORMAL: terminates EMERG_PRESSURIZE or EMERG_DEPRESSURIZE and restores the control algorithm. EMERG_PRESSURIZE: heat/cool outputs off. EMERG_DEPRESSURIZE: heat/cool outputs closed.
nviInUse		UWORD 0 to 65535		0 (if bound but fails to be received), 65535 (for 60 s at application restart)	This is used by the engineering tool or other supervisory node that it is "logged on" to the controller node. It should be set every minute, or the controller will reset it after 60s to automatically log off the supervisory node.
nviManCool		SNVT_lev_percent 0 to 100% 163.835% = INVALID			This can be used for master/slave installations where the cool output is controlled by an external controller node. In this case, the output signal of the external cool control algorithm (0-100%) has to be bound to nviManCool which would take over the task of the local (slave) control algorithm while the switch levels operate as locally configured. The heating output will be closed.
nviManHeat		SNVT_lev_percent 0 to 100% 163.835% = INVALID			This can be used for master/slave installations where the heat output is controlled by an external controller node. In this case, the output signal of the external heat control algorithm (0-100%) has to be bound to nviManHeat which would take over the task of the local (slave) control algorithm while the switch levels operate as locally configured. The cooling output will be closed.
nviManOccCmd		SNVT_occupancy OC_OCCUPIED OC_UNOCCUPIED OC_BYPASS OC_STANDBY OC_NUL	0 1 2 3 255	OC_NUL (at application restart)	This is an input from an network connected operator interface or other node that indicates the state of manual occupancy control (schedule override). It has priority over the time program (nviTodEvent). When the BYPASS mode is set, then the Bypass time is active. When the bypass time is elapsed, the master controller automatically sets nviManOccCmd to OC_NUL. nviManOccCmd does not provide a failure detect mechanism in case no periodic update is received.

Table C3: Input Variables for W7763 Controllers

NvName	Field Name	Engineering Units: English (Metric) or States plus Range	Digital State or Value	Default	Comments
nviManualMode		BYTE MODE_ENABLE MODE_DISABLE MODE_MANUAL SUPPRESS_ALARMS UNSUPPRESS_ALARMS	0 1 2 3 4	MODE_ENABLE and UNSUPPRESS_ALARMS (at application restart)	This is an input that is used to disable the controller's control algorithms in order to manually set its physical outputs. The controller still responds to smoke purge even when disabled or set to manual or factory test mode. It remains unchanged until another mode has been commanded or an application restart has been performed. <ul style="list-style-type: none"> MODE_ENABLE: starts the control algorithm at an initial state after MODE_DISABLE or MODE_MANUAL. MODE_DISABLE: all outputs switched off, the alarm ALARM_NODE_OFF is issued. MODE_MANUAL: all control loops are disabled and the alarm ALARM_NODE_OFF is issued. The outputs can be controlled manually via the nviTest command SUPPRESS_ALARMS: nvoAlarm is not sent and nvoAlarmStatus and nvoAlarmLog are not updated until UNSUPPRESS_ALARMS is set or an application restart. UNSUPPRESS_ALARMS: releases alarm suppression after SUPPRESS_ALARMS.
nviRequest	object_id	SNVT_obj_request UWORD 0=Node Object 1=Fan Coil Object			This input variable belongs to the Node Object and provides the mechanism to request a particular mode for a particular object within a node.
nviRequest	object_request	object_request_t Enum from Echelon defined RQ_NORMAL RQ_UPDATE_STATUS RQ_UPDATE_ALARM RQ_REPORT_MASK	0 2 4 5		See above. Commanding any modes other the ones listed will result in an "invalid_request" when reading nvoStatus.
nviSensorOcc		SNVT_occupancy OC_OCCUPIED OC_UNOCCUPIED OC_BYPASS OC_NUL	0 1 2 255	OC_NUL (if bound but fails to be received or at application restart)	This allows an occupancy sensor of another Excel 10 controller to be used to indicate the sensed occupancy state of the space. OC_NUL means no input is available because it is not bound, bound but not received periodically, or not configured by nciChcConfig.DI1_config. More than one occupancy sensor may be bound to nviSensorOcc. If any one sensor detects occupancy, the controller considers the space occupied.

Table C3: Input Variables for W7763 Controllers

NvName	Field Name	Engineering Units: English (Metric) or States plus Range	Digital State or Value	Default	Comments
nviSetPoint		SNVT_temp_p 10 to 35°C 327.67°C = INVALID		INVALID (at application restart)	This is an input intended for binding third party nodes to authorize them for setpoint modifications. When this has been bound and a valid update is received, the local configured setpoints will no longer be directly used to determine the current occupancy setpoint. For OCCUPIED and STANDBY modes, this is used with the appropriate ZEB (derived from the configured setpoints), for UNOCCUPIED mode the setpoint does not depend on this input, but on nciTempSetPts.unoccupied_cool/_heat only. nviSetpoint is stored in RAM and gets lost after power failure. In this case the setpoints of nciTempSetPts will be used until a valid nviSetpoint is received.
nviSetPtOffset		SNVT_temp_p -10 to 10 K 327.67°C = INVALID		0 (if bound but fails to be received or at application restart)	This is an input intended for binding third party nodes to authorize them for setpoint shifting. nviSetPtOffset is stored in RAM and will be initialized to zero after application restart or power failure. If nviSetPtOffset is bound and fails to be received periodically as configured with nciRcvHrtBt, it will be reset to zero.
nviSpaceRH		SNVT_lev_percent 163.835% = INVALID		INVALID (at application restart)	This input allows the use of a humidity sensor from another node to be used for calculating the dewpoint. The network input has priority over a sensor connected directly to the controller.
nviSpaceTemp		SNVT_temp_p 0 to 40°C 327.67°C = INVALID		INVALID (if bound but fails to be received or at application restart)	This is the space temperature transmitted from another Excel 10 controller or another node that has a temperature sensor wired to it. If bound or has a value other than INVALID, then it is used as the sensed space temperature instead of the wired wall module's temperature. nviSpaceTemp may be set to a value other than INVALID using a LNS tool when nviSpaceTemp is not bound to set the temperature to a fixed value.
nviTest	output1_cmd	BYTE NORMAL_HC_MODE OFF1_OFF2 ON1_OFF2 OFF1_ON2 ON1_ON2 TESTPOSITION		NORMAL_HC_MODE (at application restart)	This is used by factory test, OEM field test, field installation, and field testing to manually command the physical output 1 when the node has been put into manual mode (nviManualMode = MODE_MANUAL). NORMAL_HC_MODE: output 1 remains in its current position OFF1_OFF2, ON1_OFF2, OFF1_ON2, ON1_ON2: set the individual triacs on or off TESTPOSITION: sets output based on output1_test_pos.

Table C3: Input Variables for W7763 Controllers

NvName	Field Name	Engineering Units: English (Metric) or States plus Range	Digital State or Value	Default	Comments
nviTest	output1_test_pos	SNVT_lev_percent 0 to 100%		0 (at application restart)	This is used for the TESTPOSITION of the output1_cmd and is based on the configured runtime/cycle time.
nviTest	output2_cmd	BYTE NORMAL_HC_MODE OFF1_OFF2 ON1_OFF2 OFF1_ON2 ON1_ON2 TESTPOSITION	0 1 2 3 4 5	NORMAL_HC_MODE (at application restart)	Same as output1_cmd for output 2.
nviTest	output2_test_pos	SNVT_lev_percent 0 to 100%		0 (at application restart)	Same as output1_test_pos for output 2
nviTest	override_LED	BYTE NORMAL_LED_MODE LED_OFF LED_ON	0 1 2	NORMAL_LED_MODE (at application restart)	This can be used to test the wall module LED when nviManualMode = MODE_MANUAL..
nviTodEvent	current_state	SNVT_tod_event.current_state OC_OCCUPIED OC_UNOCCUPIED OC_STANDBY OC_NUL	0 1 3 255	OC_OCCUPIED (if bound but fails to be received or at application restart)	This indicates to the node whether the space is currently scheduled to be occupied, standby or unoccupied.
nviTodEvent	next_state	SNVT_tod_event.next_state OC_OCCUPIED OC_UNOCCUPIED OC_STANDBY OC_NUL	0 1 3 255	OC_OCCUPIED (if bound but fails to be received or at application restart)	This indicates to the node whether the next scheduled occupancy mode will be occupied, standby or unoccupied. This information is required by the controller to perform the optimum start strategy.
nviTodEvent	time_to_next_state	SNVT_tod_event.time_to_next_state UWORD 0 to 2880 minutes		0 (if bound but fails to be received or at application restart)	This is the time in minutes until the next change of scheduled occupancy state. This data is also used by the optimum start calculation (see nciEnergyManag).

Table C3: Input Variables for W7763 Controllers

NvName	Field Name	Engineering Units: English (Metric) or States plus Range	Digital State or Value	Default	Comments
nviEnergyHoldOff	value	SNVT_switch.value 0 to 100%		0 (if bound but fails to be received or at application restart)	This allows a window contact node or another controller to be used as remote window contact. More than one nvoEnergyHoldOff may be bound to one nviEnergyHoldOff, which allows one node to be used to handle several distributed window contacts. In this case the control process assumes an open window, if at least one bound window node detects an open window. 'Window Closed' would be assumed if all nvoEnergyHoldOffs bound to nviEnergyHoldOff indicate the window being closed for at least the failure detect time (nciSndHrtBt).
nviEnergyHoldOff	state	SNVT_switch.state CLOSED OPEN NO_WINDOW	0 1 255	NO_WINDOW (if bound but fails to be received or at application restart)	See above.

Table C4: Output Variables for W7763 Controllers

NvName	Field Name	Engineering Units: English (Metric) or States plus Range	Digital State or Value	Default	Comments
nvoActiveSetPt		SNVT_temp_p 10 to 35°C 327.67=INVALID			This is an output showing the active setpoint of the control algorithm. It is based on the occupancy setpoints, the offset and recovery ramping.
nvoAlarm	subnet	UBYTE 0 to 255			The subnet is the LONWORKS subnet number (in domain entry 1 of the node's domain table).
nvoAlarm	node	UBYTE 0 to 255			The node is the LONWORKS node number (in domain entry 1 of the node's domain table).
nvoAlarm (continued)	type	UBYTE ALM_NO_ALARM ALM_NODE_OFF ALM_FROST ALM_INVALID_SETPNT ALM_TEMP_SENSOR_FAIL ALM_SETPNT_KNOB_FAIL ALM_FAN_SPEED_SW_FAIL ALM_FAN_FAILURE ALM_COMFAIL_SPACETEMP ALM_COMFAIL_HVACMODE ALM_COMFAIL_SETPTOFFS ALM_COMFAIL_SCHDOCC ALM_COMFAIL_DLC ALM_COMFAIL_SPACE_RH ALM_COMFAIL_ODTEMP ALM_COMFAIL_OCCSENSOR ALM_COMFAIL_WINDOW ALM_COMFAIL_MANHEAT ALM_COMFAIL_MANCOOL ALM_COMFAIL_COOL_TEMP ALM_H2O_TOO_COLD ALM_CONDENSATION RETURN_TO_NORMAL RTN_NODE_OFF RTN_FROST RTN_INVALID_SETPNT RTN_TEMP_SENSOR_FAIL RTN_SETPNT_KNOB_FAIL	0 1 2 3 4 5 6 7 8 9 10 11 12 13 14 15 16 17 18 19 20 21 128 129 130 131 132 133	RETURN_TO_NORMAL (at application restart)	This is an output reporting the latest changed error condition detected in the node. The first 5 bits are used for the alarm type number, and this number is added to RETURN_TO_NORMAL (128) when the error condition is no longer true. Each error condition/return-to-normal is issued only once. The type is also recorded in nvoAlarmLog and nvoChcStatus.alarm_type. Alarm reporting is suppressed by setting nviManualMode to SUPPRESS_ALARMS, in which case nvoAlarm.type is set to ALARM_NOTIFY_DISABLED. Alarm reporting is turned on again by setting nviManualMode to UNSUPPRESS_ALARMS, after which all existing alarms (or ALM_NO_ALARM) are reported one at a time.

Table C4: Output Variables for W7763 Controllers

NvName	Field Name	Engineering Units: English (Metric) or States plus Range	Digital State or Value	Default	Comments
nvoAlarm		RTN_COMFAIL_SPACETEMP RTN_COMFAIL_HVACMODE RTN_COMFAIL_SETPTOFFS RTN_COMFAIL_SCHEDOCC RTN_COMFAIL_DLC RTN_COMFAIL_SPACE_RH RTN_COMFAIL_ODTEMP RTN_COMFAIL_OCCSENSOR RTN_COMFAIL_WINDOW RTN_COMFAIL_MANHEAT RTN_COMFAIL_MANCOOL RTN_COMFAIL_COOL_TEMP RTN_COMFAIL_H2O_TOO_COLD RTN_COMFAIL_CONDENSATION ALARM_NOTIFY_DISABLED	136 137 138 139 140 141 142 143 144 145 146 147 148 149 255		
nvoAlarmLog	alarm_type[0]	Same as nvoAlarm.type		See nvoAlarm.type	A central node may poll the nvoAlarmLog output for a short history of alarms. It contains the last five alarms reported via nvoAlarm. At the time a new nvoAlarm is issued, nvoAlarmLog is updated.
nvoAlarmLog	alarm_type[1]	Same as nvoAlarm.type		See nvoAlarm.type	See above.
nvoAlarmLog	alarm_type[2]	Same as nvoAlarm.type		See nvoAlarm.type	See above.
nvoAlarmLog	alarm_type[3]	Same as nvoAlarm.type		See nvoAlarm.type	See above.
nvoAlarmLog	alarm_type[4]	Same as nvoAlarm.type		See nvoAlarm.type	See above. nvoAlarmLog.alarm_type[4] is the oldest alarm.
nvoAlarmStatus	error_bit[0]	UBYTE Bit coded Alarm: ALM_NODE_OFF ALM_FROST ALM_INVALID_SETPNT ALM_TEMP_SENSOR_FAIL ALM_SETPNT_KNOB_FAIL ALM_COMFAIL_SPACETEMP	1 2 4 8 16 128		This is a polled output containing a list of all the current errors detected by the node. A search for error conditions in the node is made periodically. A central node may poll the nvoAlarmStatus output for all of the current errors. nvoAlarmStatus contains all the current detected errors even though they may be suppressed for reporting by nvoAlarm.

Table C4: Output Variables for W7763 Controllers

NvName	Field Name	Engineering Units: English (Metric) or States plus Range	Digital State or Value	Default	Comments
nvoAlarmStatus	error_bit[1]	UBYTE Bit coded Alarm: ALM_COMFAIL_HVACMODE ALM_COMFAIL_SETPTOFFS ALM_COMFAIL_SCHEDOCC ALM_COMFAIL_DLC ALM_COMFAIL_TEMPRESET ALM_COMFAIL_ODTEMP ALM_COMFAIL_OCCSENSOR ALM_COMFAIL_WINDOW	 1 2 4 8 16 32 64 128		See above.
nvoAlarmStatus	error_bit[2]	UBYTE Bit coded Alarm: ALM_COMFAIL_MANHEAT ALM_COMFAIL_MANCOOL ALM_HW_SW_MISMATCH	 1 2 4		See above.
nvoApplicMode		SNVT_hvac_mode HVAC_AUTO HVAC_HEAT HVAC_COOL HVAC_OFF	 0 1 3 6	HVAC_OFF (at application restart)	This is an output used to coordinate the slave devices with the master controller. It reflects the current heat/cool medium based on supply energy available. This is required for configurations with heat/cool changeover. HVAC_OFF switches the heat/cool control off while still providing frost protection and reporting status and alarms.
nvoCoolOutput		SNVT_lev_percent 0 to 100% 163.835% = INVALID			This is the cooling output that is typically used for monitoring or bound to a cooling actuator node or another controller operating as slave. nvoCoolOutput will be transmitted immediately when its value has changed significantly ($\geq 1\%$), and periodically according to nciSndHrtBt. The output value represents the output of the control algorithm but is limited to a range of 0% to 100%.
nvoDigitInState	value	SNVT_switch.value 0 to 100%			This indicates the binary states of the controller's digital input which can be configured to support a window contact, an occupancy sensor, an airflow contact, heat/cool changeover contact or monitoring contact. It can be bound to another Excel 10 controller or a third party node.
nvoDigitInState	state	SNVT_switch.state OFF	0		See above.

Table C4: Output Variables for W7763 Controllers

NvName	Field Name	Engineering Units: English (Metric) or States plus Range	Digital State or Value	Default	Comments
		ON NOT_ASSIGNED	1 255		
nvoEffectOcc		SNVT_occupancy OC_OCCUPIED OC_UNOCCUPIED OC_BYPASS OC_STANDBY	0 1 2 3		This is the output reflecting the effective occupancy mode derived from the time schedule, occupancy sensor, override button, and network occupancy override.
nvoChcStatus	field_no	UBYTE FIELD_EFFECT_OCC FIELD_HW_OVERRIDE FIELD_SCHED_OCC FIELD_EFF_SEN_OCC FIELD_NET_MAN_OCC FIELD_HW_SEN_OCC FIELD_R_O_LED FIELD_MODE FIELD_ALARM_TYPE FIELD_DLC_SHED FIELD_EFF_WINDOW_OPEN FIELD_HW_WINDOW_OPEN FIELD_EXTERNAL_ACTIVE FIELD_CONDENSATION_STATE FIELD_OUTPUT_POS_1 FIELD_OUTPUT_POS_2 FIELD_REHEAT_RELAY FIELD_ACTIVE_SET_PT FIELD_SPACE_TEMP FIELD_COOL_TEMP FIELD_HUMIDITY FIELD_REST_BYPASS_TIME	1 2 3 4 5 6 7 8 9 10 11 12 14 15 17 18 19 20 21 22 23 24		This is used to indicate which other data field in nvoChcStatus has changed since the last time nvoChcStatus was sent on the network. If any field has had a significant change, only that field is updated, and field_no indicates which field. If three or more fields have changed significantly, then all fields are updated and field_no is set to 0. All fields are also updated every refresh time (55s).
nvoChcStatus	effect_occ	SNVT_occupancy OC_OCCUPIED OC_UNOCCUPIED OC_BYPASS	0 1 2		This is the effective occupancy mode resulting from scheduled occupancy mode, occupancy sensor information, bypass push-button, or manual operator interface.

Table C4: Output Variables for W7763 Controllers

NvName	Field Name	Engineering Units: English (Metric) or States plus Range	Digital State or Value	Default	Comments
		OC_STANDBY	3		
nvoChcStatus	hw_override	SNVT_occupancy OC_UNOCCUPIED OC_BYPASS OC_NUL (No Override)	0 2 255		It reports the current state of the remote override button.
nvoChcStatus nvoChcStatus (continued)	sched_occ	SNVT_occupancy OC_OCCUPIED OC_UNOCCUPIED OC_BYPASS OC_STANDBY OC_NUL (No Override)	0 1 2 3 255		It reports the current scheduled occupancy received via the network.
nvoChcStatus	eff_sen_occ	SNVT_occupancy OC_OCCUPIED OC_UNOCCUPIED OC_NUL (No Override)	0 1 255		This reports the effective state of occupancy sensor(s) connected either to the input terminals from the network.
nvoChcStatus	net_man_occ	SNVT_occupancy OC_OCCUPIED OC_UNOCCUPIED OC_BYPASS OC_STANDBY OC_NUL	0 1 2 3 255		This reports the manual occupancy from the network.
nvoChcStatus	hw_sen_occ	SNVT_occupancy OC_OCCUPIED OC_UNOCCUPIED OC_NUL	0 1 255		It reports the state of the occupancy sensor wired to the node.
nvoChcStatus	r_o_led	SNVT_occupancy OC_OCCUPIED OC_UNOCCUPIED OC_BYPASS OC_STANDBY OC_NUL	0 1 2 3 255		This variable reports the current state of the remote override LED which indicates the effective schedule override resulting from the bypass push-button or a network override. OC_OCCUPIED: 2 flashes per second OC_UNOCCUPIED: 1 flash per second OC_BYPASS: on OC_STANDBY: 2 flashes per second OC_NUL: off

Table C4: Output Variables for W7763 Controllers

NvName	Field Name	Engineering Units: English (Metric) or States plus Range	Digital State or Value	Default	Comments
nvoChcStatus <i>(continued)</i> nvoChcStatus	mode	BYTE CTL_COOL CTL_HEAT CTL_PRESSURIZE CTL_DE_PRESSURIZE CTL_MODE_MANUAL CTL_MODE_FACTORY_TEST CTL_FLOATING_OUT_SYNC CTL_START_UP_WAIT CTL_DISABLED	0 1 2 3 4 5 6 8 255		This is the current operating mode of the node determined by many inputs and arbitrated by control logic. CTL_PRESSURIZE and CTL_DE_PRESSURIZE disable the heat/cool outputs. CTL_MODE_MANUAL allows turning on and off outputs manually through nviTest. CTL_MODE_FACTORY_TEST is intended only for the factory. CTL_FLOATING_OUT_SYNC allows enough time (150% valve run time) for the valve(s) are at their initial positions (control algorithms are active). The controller then goes into one of the normal operating modes, such as CTL_COOL. When the effective occupancy changes to unoccupied or 24 hours have elapsed since the last start-up or CTL_FLOATING_OUT_SYNC mode, the controller enters this mode again to reset the floating output position tracking. CTL_START_UP_WAIT is the first mode after an application restart. No control algorithms are active, and heat/cool outputs stay in their default positions. CTL_FLOATING_OUT_SYNC follows. CTL_DISABLED disables heat/cool control.
nvoChcStatus	alarm_type	Same as nvoAlarm.type			This is the latest alarm detected by the node (if any) and has the same value as nvoAlarm.type.
nvoChcStatus	dlc_shed	Bit NOT ACTICE ACTIVE	0 1		This indicates the state of the demand limit control.
nvoChcStatus	eff_window_open	Bit CLOSED or NOT_ASSIGNED OPEN	0 1		This indicates the real status of the window detection, either from the digital input or from the network.
nvoChcStatus	hw_window_open	Bit CLOSED or NOT_ASSIGNED OPEN	0 1		This indicates the status of the digital input configured as window detection.
nvoChcStatus	condensation_state	Bit NO_CONDENSATION CONDENSATION	0 1		This output indicates the status of the condensation switch, if configured for one. If not configured, the status is 0.
nvoChcStatus	output_position[0]	SNVT_lev_percent			This indicates the position of the output 1.

Table C4: Output Variables for W7763 Controllers

NvName	Field Name	Engineering Units: English (Metric) or States plus Range	Digital State or Value	Default	Comments
		0 to 100% 163.835% = INVALID			
nvoChcStatus	output_position[1]	SNVT_lev_percent 0 to 100% 163.835% = INVALID			This indicates the position of the output 2.
nvoChcStatus	active_set_pt	SNVT_temp_p 10 to 35°C 327.67°C = INVALID			This reports the current temperature control point calculated from the various setpoints, operating modes, and optimum start-up gradients.
nvoChcStatus	space_temp	SNVT_temp_p 0 to 40°C 327.67°C = INVALID			This reports the current space temperature used for the control algorithm.
nvoChcStatus	cool_temp	SNVT_temp_p 0 to 70°C 327.67°C = INVALID			This output provides the chilled water temperature from the sensor connected directly to the controller. If not configured, it shows INVALID.
nvoChcStatus	humidity	SNVT_lev_percent 0 to 100% 163.835% = INVALID			The output provides the humidity from the humidity sensor connected directly to the controller. If not configured, it shows INVALID.
nvoChcStatus	rest_bypass_time	UWORD 0 to 65535 Min			This shows the current value in minutes of the active bypass timer
nvoChcStatusP	field_no	Same as nvoChcStatus.			Same as nvoChcStatus except not sent as heartbeat. This variable is sent only in response to a poll request, typically from a supervisory device.
nvoChcStatusP	effect_occ	Same as nvoChcStatus.			Same as nvoChcStatus.
nvoChcStatusP	hw_override	Same as nvoChcStatus.			Same as nvoChcStatus.
nvoChcStatusP	sched_occ	Same as nvoChcStatus.			Same as nvoChcStatus.
nvoChcStatusP	eff_sen_occ	Same as nvoChcStatus.			Same as nvoChcStatus.
nvoChcStatusP	net_man_occ	Same as nvoChcStatus.			Same as nvoChcStatus.
nvoChcStatusP	hw_sen_occ	Same as nvoChcStatus.			Same as nvoChcStatus.
nvoChcStatusP	r_o_led	Same as nvoChcStatus.			Same as nvoChcStatus.
nvoChcStatusP	mode	Same as nvoChcStatus.			Same as nvoChcStatus.

Table C4: Output Variables for W7763 Controllers

NvName	Field Name	Engineering Units: English (Metric) or States plus Range	Digital State or Value	Default	Comments
nvoChcStatusP	alarm_type	Same as nvoChcStatus.			Same as nvoChcStatus.
nvoChcStatusP	dlc_shed	Same as nvoChcStatus.			Same as nvoChcStatus.
nvoChcStatusP	eff_window_open	Same as nvoChcStatus.			Same as nvoChcStatus.
nvoChcStatusP	hw_window_open	Same as nvoChcStatus.			Same as nvoChcStatus.
nvoChcStatusP	condensation_state	Same as nvoChcStatus			Same as nvoChcStatus.
nvoChcStatusP	output_position[0]	Same as nvoChcStatus.			Same as nvoChcStatus.
nvoChcStatusP	output_position[1]	Same as nvoChcStatus.			Same as nvoChcStatus.
nvoChcStatusP	active_set_pt	Same as nvoChcStatus.			Same as nvoChcStatus.
nvoChcStatusP	cool_temp	Same as nvoChcStatus.			Same as nvoChcStatus.
nvoChcStatusP	humidity	Same as nvoChcStatus.			Same as nvoChcStatus.
nvoChcStatusP	space_temp	Same as nvoChcStatus.			Same as nvoChcStatus.
nvoChcStatusP	rest_bypass_time	Same as nvoChcStatus.			Same as nvoChcStatus.
nvoHeatOutput		SNVT_lev_percent 0 to 100% 163.835% = INVALID			This is the heating output which is typically used for monitoring or bound to a heat actuator node or another Excel 10 controller operating as slave. nvoHeatOutput will be transmitted immediately when its value has changed significantly ($\geq 1\%$), and periodically according to nciSndHrtBt. The output value represents the output of the control algorithm but is limited to a range of 0% to 100%.
nvoSensor	override_button	Bit NOT_PRESSED PRESSED	0 1		This indicates the status of the override push-button.
nvoSensor	contact_state_DI1	Bit CONTACT_OPEN CONTACT_CLOSED	0 1		This indicates the state of the digital input.
nvoSensor	raw_data[0]	UWORD 0 to 65535 for Space Temp			This contains the analog to digital converter count measured from the analog value. This count represents the measured time during the second part of each a/d conversion.
nvoSensor	raw_data[2]	UWORD 0 to 65535 for Setpoint Knob			See above.

Table C4: Output Variables for W7763 Controllers

NvName	Field Name	Engineering Units: English (Metric) or States plus Range	Digital State or Value	Default	Comments
nvoSensor	remote_set_point	SNVT_temp_p -5 to 5 K for relative 12 to 30°C for absolute			This is the set point from the wall module setpoint knob and may be absolute or relative depending upon nciWallMod.set_pnt_knob.
nvoSensor	space_temp	SNVT_temp_p 0 to 40°C 327.67°C for INVALID			This is the measured space temperature accurately reported between 0°C and 40°C.
nvoSensor	ub_hard_config	BYTE INITIAL W7763C W7763D W7763E INVALID	0 3 4 5 255	INITIAL (at application restart)	This is used to establish hardware-dependent factory default configuration settings for the Chilled Ceiling controller.
nvoSensorOcc		SNVT_occupancy OC_OCCUPIED OC_UNOCCUPIED OC_NUL (No Sensor)	0 1 255	OC_NUL (at application restart)	This is an output showing the state of the hard wired occupancy sensor, if one is configured by nciChcConfig.DI1_config. OC_NUL means no input is available because it is not bound or not configured by nciChcConfig.DI1_config.
nvoSpaceDewPt		SNVT_temp_p 0 to 40°C 327.67°C = INVALID		INVALID (at application restart)	This output reports the dewpoint calculated by the controller based on room temperature and humidity.
nvoSpaceTemp		SNVT_temp_p 0 to 40°C 327.67°C = INVALID		INVALID (at application restart)	This is the sensed space temperature at the node taken from the locally wired sensor. It is typically bound to nviSpaceTemp of another node that may not have its own space temperature sensor but controls the same space. It is also used for monitoring purposes, showing the current space temperature used for the control algorithm. nvoSpaceTemp is transmitted immediately when its value has changed significantly (> 0.5 delta°C). The reported space temperature includes the offset correction nciWallMod.si_space_temp_zero_cal. If a space temperature sensor is not connected or is shorted or if nviSpaceTemp is bound to another node, nvoSpaceTemp is not reported on the network.
nvoStatus	object_id	UWORD NODE_OBJECT	0		This output belongs to the Node Object and reports the status for any object on a node. This is the answer to the nviRequest.

Table C4: Output Variables for W7763 Controllers

NvName	Field Name	Engineering Units: English (Metric) or States plus Range	Digital State or Value	Default	Comments
		CHC_OBJECT	1		
nvoStatus	invalid_id	Bit VALID_ID INVALID_ID	0 1		This indicates whether nviRequest uses a fault object ID.
nvoStatus	invalid_request	Bit VALID_REQUEST INVALID_REQUEST	0 1		This indicates whether nviRequest uses a fault request.
nvoStatus	disabled	Bit ENABLED DISABLED	0 1		This indicates whether the device is enabled or disabled (nviManualMode = DISABLE).
nvoStatus	comm_failure	Bit COMMUNICATION_OK COMMUNICATION_FAILURE	0 1		This indicates whether an update nviRcvHrtBt is missing.
nvoStatus	in_alarm	Bit NO_ALARM IN_ALARM	0 1		This indicates whether an alarm occurred. See nvoAlarm.
nvoStatus	report_mask	Bit NO_REPORT_MASK REPORT_MASK	0 1		This shows the answer to nviRequest > REPORT_MASK
nvoTerminalLoad		SNVT_lev_percent -163...163% 163.835% = INVALID			This is an output showing the terminal load, which is a percentage between -160% and +160% based on the control output level. Negative values indicate heating load and positive values indicate cooling load. 100% is the full terminal capacity. An absolute terminal load value of more than 100% indicate that the terminal is not able to supply the required heating or cooling energy which at the zone controller should cause a demand for more supply energy. nvoHeatOutput will be transmitted immediately when its value has changed significantly ($\geq 1\%$).
nvoUnitStatus	mode	SNVT_hvac_mode HVAC_HEAT HVAC_COOL	1 3		This output variable reports the last operating mode of the control algorithm. It is not set to HVAC_OFF if the Heating and Cooling Output shows 0%. HVAC_OFF is set when the Device

Table C4: Output Variables for W7763 Controllers

NvName	Field Name	Engineering Units: English (Metric) or States plus Range	Digital State or Value	Default	Comments
		HVAC_OFF	6		is disabled from nviRequest, nviManualMode or nviApplicMode.
nvoUnitStatus	heat_output_primary	SNVT_lev_percent 0 to 100% 163.835% = INVALID			This reports the actual heating output value. Any change forces nvoUnitStatus to be transmitted immediately.
nvoUnitStatus	cool_output	SNVT_lev_percent 0 to 100% 163.835% = INVALID			This reports the actual cooling output value. A change of more than 1% forces nvoUnitStatus to be transmitted immediately.
nvoUnitStatus	in_alarm	UBYTE NO_ALARM ALARM ALARM_NOTIFY_DISABLED	0 1 255		This reports the actual alarm status of the controller and is set to ALARM_NOTIFY_DISABLE when nviManualMode = SUPPRESS_ALARMS.
nvoEnergyHoldOff	value	SNVT_switch.value 0 to 100%		0 (at application restart)	This reports the status of the window sensor. It allows the hard wired window sensor to be used by other nodes on the network.
nvoEnergyHoldOff	state	SNVT_switch.state CLOSED OPEN NO_WINDOW	0 1 255	NO_WINDOW (at application restart)	See above.
nroPgmVer	id[0]	UBYTE, 67 = C			This identifies the Excel 10 node type by an eight byte constant describing the node type, major and minor functional release number and bug fix. First character.
nroPgmVer	id[1]	UBYTE, 72 = H			Second character.
nroPgmVer	id[2]	UBYTE, 67 = C			Third character.
nroPgmVer	id[3]	UBYTE, 49 = 1			Fourth character.
nroPgmVer	major_ver	UBYTE, 0 to 255			Major Functional Release Number: 1. Add or delete a network variable (NV), nv field. 2. Change the name of a nv or nv field. 3. Range or type (short / long) of data in a nv field is

Table C4: Output Variables for W7763 Controllers

NvName	Field Name	Engineering Units: English (Metric) or States plus Range	Digital State or Value	Default	Comments
					changed. 4. Enumerated value list of a nv field is changed. NOTE: Algorithm changes or bug fixes may also be included.
NroPgmVer	minor_ver	UBYTE, 0 to 255			Minor Functional Release Number: 1. Network variables are unchanged. 2. Functionality of the control algorithm has been revised and affects compatibility with other nodes or the equipment being controlled. 3. The network interface or physical input / output subsystem was revised and affects compatibility with other nodes. NOTE: Bug fixes may also be included in a minor functional release.
nroPgmVer	bug_ver	UBYTE, 0 to 255			Bug Fix Number: Network variables are unchanged. A change to the algorithm, network interface, or physical input/output subsystem was made that does not affect compatibility with other nodes or the equipment controlled by the node.
nroPgmVer	node_type	UBYTE, 22 = CHC1			Node type number.

Table C5: Unused Variables for W7763 Controllers

NvName	Field Name	Engineering Units: English (Metric) or States plus Range	Digital State or Value	Default	Comments
nciAppVer	not_used1	UBYTE			
nciAppVer	not_used2	UBYTE			
nciCntrlSettings	reheat_switch_level	SNVT_lev_percent 0 to 100%		100%	
nciCntrlSettings	reheat_hysteresis	SNVT_lev_percent 0 to 100%		5%	
nciCntrlSettings	reserve	7 bits			
nciChcConfig	not_used	3 bits			
nciChcConfig	reheat_config	BYTE REHEAT FREE_USE REL_NOT_USED	0 1 255	REL_NOT_USED	
nciChcConfig	unused1	2 bits			
nciChcConfig	spare_field[0]	UBYTE			
nciChcConfig	spare_field[1]	UBYTE			
nciWallMod	spare_field[0]	UBYTE			
nciWallMod	spare_field[1]	UBYTE			
nviReheatRelay	value	SNVT_switch 0 to 100%			
nviReheatRelay	state	SNVT_switch OFF ON NUL			
nviTest	reheat_cmd	BYTE NORMAL_HC_MODE OFF1_OFF2 ON1_ON2	0 1 4	NORMAL_HC_MODE	
nvoChcStatus	external_active	Bit EXTERNAL_NOT_ACTICE EXTERNAL_ACTIVE	0 1		

Table C5: Unused Variables for W7763 Controllers

NvName	Field Name	Engineering Units: English (Metric) or States plus Range	Digital State or Value	Default	Comments
nvoChcStatus	not_used	2 bits			
nvoChcStatus	reheat_active	SNVT_lev_disc ST_OFF ST_ON ST_NUL (No Reheat)	0 4 255		
nvoChcStatus	spare_field[0]	WORD			
nvoChcStatusP	external_active	Same as nvoChcStatus			
nvoChcStatusP	not_used	Same as nvoChcStatus			
nvoChcStatusP	reheat_active	Same as nvoChcStatus			
nvoChcStatusP	spare_field[0]	Same as nvoChcStatus			
nvoReheat	value	SNVT_switch.value 0 to 100%			
nvoReheat	state	SNVT_switch.state OFF ON NO_REHEAT	0 1 2		
nvoSensor	not_used	6 bits			
nvoSensor	raw_data[1]	UWORD 0 to 65535			
nvoStatus	out_of_limits	Bit not supported			
nvoStatus	open_circuit	Bit not supported			
nvoStatus	out_of_service	Bit not supported			
nvoStatus	mechanical_fault	Bit not supported			
nvoStatus	feedback_failure	Bit not supported			
nvoStatus	over_range	Bit not supported			
nvoStatus	under_range	Bit not supported			
nvoStatus	electrical_fault	Bit not supported			
nvoStatus	unable_to_measure	Bit not supported			

Table C5: Unused Variables for W7763 Controllers

NvName	Field Name	Engineering Units: English (Metric) or States plus Range	Digital State or Value	Default	Comments
nvoStatus	fail_self_test	Bit not supported			
nvoStatus	self_test_in_progress	Bit not supported			
nvoStatus	locked_out	Bit not supported			
nvoStatus	manual_control	Bit not supported			
nvoStatus	in_override	Bit not supported			
nvoStatus	reserved1	Bit not supported			
nvoStatus	reserved2	Bit not supported			
nvoUnitStatus	heat_output_secondary	SNVT_lev_percent 0 to 100% 163.835% = INVALID			
nvoUnitStatus	econ_output	SNVT_lev_percent not supported			

Honeywell

Manufactured for and on behalf of the Environmental and Combustion Controls Division of Honeywell Technologies Sàrl, Rolle, Z.A. La Pièce 16, Switzerland by its Authorized Representative:

Automation and Control Solutions

Honeywell GmbH
Böblinger Strasse 17
71101 Schönaich
Germany

Phone: (49) 7031 63701

Fax: (49) 7031 637493

<http://ecc.emea.honeywell.com>

Subject to change without notice. Printed in Germany

74-3332-2r0311